

# **CONNECTICUT PUBLIC HEALTH CODE**

## **Regulations and Technical Standards for Subsurface Sewage Disposal Systems**

Section 19-13-B100a (Building Conversions, Changes in Use, Additions)  
Effective August 3, 1998

Section 19-13-B103 (Discharges 5,000 Gallons Per Day or Less)  
Effective August 16, 1982

Technical Standards (Pursuant to Section 19-13-B103)  
Effective August 16, 1982

Revised January 1, 1986

Revised January 1, 1989

Revised January 1, 1992

Revised January 1, 1994

Revised January 1, 1997

Revised January 1, 2000

Revised January 1, 2004

Section 19-13-B104 (Discharges Greater than 5,000 Gallons Per Day)  
Effective August 16, 1982

State of Connecticut  
Department of Public Health  
Environmental Engineering Program  
410 Capitol Avenue - MS #51SEW  
P.O. Box 340308  
Hartford, Connecticut 06134

[www.dph.state.ct.us/BRS/Sewage/sewage\\_program.htm](http://www.dph.state.ct.us/BRS/Sewage/sewage_program.htm)

January 2004

## TABLE OF CONTENTS

<u>SECTION</u>		<u>PAGE</u>
19-13-B100a	Building Conversions, Changes in Use, Additions.....	1
19-13-B103	Discharges 5,000 Gallons Per Day or Less.....	4
19-13-B103a	Scope.....	4
19-13-B103b	Definitions.....	4
19-13-B103c	General Provisions.....	5
19-13-B103d	Minimum Requirements.....	6
19-13-B103e	Procedures and Conditions for the Issuance of Permits and Approvals.....	9
19-13-B103f	Non-discharging Sewage Disposal Systems.....	13
<b>TECHNICAL STANDARDS</b>		
I	Definitions.....	15
II	Location of Subsurface Sewage Disposal Systems.....	17
III	Piping.....	18
IV	Design Flows.....	27
V	Septic Tanks.....	28
VI	Distribution of Septic Tank Effluent.....	33
VII	Percolation Tests.....	36
VIII	Leaching Systems.....	37
IX	Groundwater, Roof, Cellar and Yard Drainage.....	47
X	Other Wastewater.....	47
XI	Non-Discharging Sewage Disposal Systems.....	47
FORM #1	Application for Permit to Construct or Repair a Sewage Disposal System.....	49
FORM #2	Investigation for Sewage Disposal System.....	50
FORM #3	Check List -Review of Plan/Inspection of Sewage Disposal System.....	52

<u>SECTION</u>		<u>PAGE</u>
APPENDIX A	Minimum Leaching System Spread (MLSS).....	53
APPENDIX B	Approved Septic Tank Outlet Filters.....	56
APPENDIX C	Approved Filter Fabric.....	56
APPENDIX D	Approved Non-Concrete Septic Tanks.....	57
19-13-B104	Discharges Greater Than 5,000 Gallons Per Day	
19-13-B104a	Scope.....	58
19-13-B104b	Definitions.....	58
19-13-B104c	General Provisions.....	58
19-13-B104d	Minimum Requirements.....	60

# **PUBLIC HEALTH CODE REGULATION**

## **Building Conversions, Changes In Use, Additions**

### **19-13-B100a. Building Conversions/Changes in Use, Building Additions, Garages/Accessory Structures, Swimming Pools, Sewage Disposal Area Preservation.**

(a) Definitions. As used in this section:

- (1) “Accessory structure” means a permanent non-habitable structure which is not served by a water supply and is used incidental to residential or non-residential buildings. Accessory structures include, but are not limited to, detached garages, open decks, tool and lawn equipment storage sheds, gazebos, and barns.
- (2) “Building conversion” means the act of winterizing a seasonal use building into year round use by providing one or more of the following: (A) a positive heating supply to the converted area; or, (B) a potable water supply which is protected from freezing; or, (C) energy conservation in the form of insulation to protect from heat loss.
- (3) “Change in use ” means any structural, mechanical or physical change to a building which allows the occupancy to increase; or the activities within the building to expand or alter such that, when the building is fully utilized, the design flow or required effective leaching area will increase.
- (4) “Code-complying area” means an area on a property where a subsurface sewage disposal system can be installed which meets all requirements of Section 19-13-B103 of the Regulations of Connecticut State Agencies, and the Technical Standards except for the one hundred percent reserve leaching area referred to in Section VIII A of the Technical Standards.
- (5) “Design flow” means the anticipated daily discharge from a building as determined in accordance with Sections IV and VIII F of the Technical Standards.
- (6) “Potential repair area” means an area on a property which could be utilized to repair or replace an existing or failed septic system and includes areas on the property where exceptions to Section 19-13-B103 of the Regulations of Connecticut State Agencies could be granted by the local director of health or the Commissioner of Public Health but does not include areas beyond those necessary for a system repair and areas of exposed ledgerrock.
- (7) “Technical Standards” means those standards established by the Commissioner of Public Health in the most recent revision of the publication entitled “Technical Standards for Subsurface Sewage Disposal Systems” prepared pursuant to Section 19-13-B103d (d) of the Regulations of Connecticut State Agencies. These standards can be obtained from the Department of Public Health, 410 Capitol Avenue, MS #51SEW, P.O. Box 340308, Hartford, CT. 06134-0308, or by calling (860) 509-7296.

(b) Building conversion, change in use. If public sewers are not available, no building or part thereof shall be altered so as to enable its continuous occupancy by performing any building conversion, nor shall there be a change in use unless the local director of health has determined that after the conversion or change in use, a code-complying area exists on the lot for installation of a subsurface sewage disposal system. The determination by the local director of health of whether a code-complying area exists on the property shall be based upon analysis of existing soil data. If soil data is not available, the property owner shall perform soil testing. The property owner or the owner’s authorized agent shall submit design plans or a sketch to demonstrate how the property contains a code-complying area that can accommodate a sewage disposal system. The local director of health may require expansion of the existing sewage disposal system or installation of a new sewage disposal system at the time of the change in use for those properties whenever the proposed change in use results in a more than 50% increase in the design flow.

(c) Building additions. If public sewers are not available, no addition to any building shall be permitted unless the local director of health has determined that after the building addition a code-complying area exists on the lot for the installation of a subsurface sewage disposal system. Once a code-complying area is identified, portions of the property outside this designated area may be utilized for further development of the property. This determination by the local director of health shall be based upon analysis of existing soil data to determine if a code-complying area exists. If soil data is not available, the property owner shall perform soil testing. The property owner or the owner's authorized agent shall submit design plans or a sketch to demonstrate how the property contains a code-complying area that can accommodate a sewage disposal system. If the applicant submits soil test data, design plans or a sketch and is unable to demonstrate a code-complying area, the building addition shall be permitted, provided:

- (1) The size of the replacement system shown on design plans or sketch provides a minimum of 50% of the required effective leaching area per the Technical Standards,
- (2) The replacement system shown on the plans or sketch provides a minimum of 50% of the required Minimum Leaching System Spread (MLSS) per the Technical Standards,
- (3) The proposed design does not require an exception to Section 19-13-B103d (a)(3) of the Regulations of Connecticut State Agencies, regarding separation distances to wells,
- (4) The addition does not reduce the potential repair area, and
- (5) The building addition does not increase the design flow of the building.

The local director of health may require expansion of the existing sewage disposal system or installation of a new sewage disposal system at the time of building addition whenever the proposed addition results in a more than 50% increase in the design flow. The separation distance from an addition to any part of the existing sewage disposal system shall comply with Table 1 in Section II of the Technical Standards.

- (d) Attached or detached garages, accessory structures, below or above ground pools. If public sewers are not available, no attached garage, detached garage, accessory structure, below or above ground pool shall be permitted unless the local director of health has determined that after construction of the attached garage, detached garage, accessory structure, below or above ground pool, a code-complying area exists on the lot for installation of a subsurface sewage disposal system. This determination by the local director of health shall be based upon analysis of existing soil data. If soil data is not available, the property owner shall perform soil testing. The property owner or the owner's authorized agent shall submit design plans or a sketch to demonstrate how the property contains a code-complying area that can accommodate a sewage disposal system. If the applicant submits soil test data, design plans or a sketch and is unable to demonstrate a code-complying area, the attached or detached garage, below or above ground pool, or accessory structure shall be permitted, provided the structure does not reduce the potential repair area. The separation distance from the attached or detached garage, below or above ground pool, or accessory structure to any part of the existing sewage disposal system shall comply with Table 1 in Section II of the Technical Standards.
- (e) Sewage disposal area preservation. If public sewers are not available, no lot line shall be relocated or any other activity performed that affects soil characteristics or hydraulic conditions so as to reduce the potential repair area, unless the local director of health has determined that after the lot line relocation or disturbance of soils on the lot a code-complying area exists for the installation of a subsurface sewage disposal system. This determination by the local director of health shall be based upon analysis of existing soil data. If soil data is not available, the property owner shall perform soil testing. The property owner or the owner's authorized agent shall submit design plans or a sketch to demonstrate how the property contains a code-complying area that can accommodate a sewage disposal system. In no case shall a relocated lot line violate Subsection (d) of Section 19-13-B103(d) of the Regulations of Connecticut State Agencies that requires that each subsurface sewage disposal system shall be located on the same lot as the building served.

- (f) Decision by Director of Health. Any final decision of the local director of health made in regard to this section shall be made in writing and sent to the applicant. Any decision adverse to the applicant or which limits the application shall set forth the facts and conclusions upon which the decision is based. Such written decision shall be deemed equivalent to an order, and may be appealed pursuant to Section 19a-229 of the Connecticut General Statutes.

## **STATEMENT OF PURPOSE**

The regulations up-date and clarify existing requirements for maintaining subsurface sewage disposal areas on lots which are served by on-site subsurface sewage disposal systems. The purpose is to regulate building conversions; activities which would potentially increase the water usage discharged to a subsurface sewage disposal system; construction activities or lot line changes which would reduce the area available for sewage disposal purposes.

Effective August 3, 1998

# PUBLIC HEALTH CODE REGULATIONS

## On-Site Sewage Disposal Systems with Design Flows of 5,000 Gallons per Day or Less and Non-Discharging Toilet Systems

### 19-13-B103a. Scope

These regulations establish minimum requirements for household and small commercial subsurface sewage disposal systems with a capacity of 5,000 gallons per day or less, non-discharging toilet systems and procedures for the issuance of permits or approvals of such systems by the director of health or registered sanitarian, as required by Section 25-54i(g) of the General Statutes.

### 19-13-B103b. Definitions

The following definitions shall apply for the purposes of Sections 19-13-B103c to 19-13-B103f, inclusive:

- (a) **Sewage** means domestic sewage consisting of water and human excretions or other waterborne wastes incidental to the occupancy of a residential building or a non-residential building, as may be detrimental to the public health or the environment, but not including manufacturing process water, cooling water, waste water from water softening equipment, blow down from heating or cooling equipment, water from cellar or floor drains or surface water from roofs, paved surface or yard drains.
- (b) **Septic tank** means a water-tight receptacle which is used for the treatment of sewage and is designed and constructed so as to permit the settling of solids, the digestion of organic matter by detention and the discharge of the liquid portion to a leaching system.
- (c) **Subsurface sewage disposal system** means a system consisting of a house sewer; a septic tank followed by a leaching system, any necessary pumps and siphons, and any groundwater control system on which the operation of the leaching system is dependent.
- (d) **Residential building** means any house, apartment, trailer or mobile home, or other structure occupied by individuals permanently or temporarily as a dwelling place but not including residential institutions.
- (e) **Residential institution** means any institutional or commercial building occupied by individuals permanently or temporarily as a dwelling, including dormitories, boarding houses, hospitals, nursing homes, jails, and residential hotels or motels.
- (f) **Nonresidential building** means any commercial, industrial, institutional, public or other building not occupied as a dwelling, including transient hotels and motels.
- (g) **Impervious soil** means soil that has a minimum percolation rate slower than one inch in sixty minutes when the groundwater level is at least eighteen inches below the bottom of the percolation test hole.
- (h) **Suitable soil** means soil having a minimum percolation rate of one inch in one to sixty minutes when the groundwater level is at least eighteen inches below the bottom of the percolation test hole.
- (i) **Maximum groundwater level** means the level to which groundwater rises for a duration of one month or longer during the wettest season of the year.
- (j) **Open watercourse** means a well defined surface channel, produced wholly or in part by a definite flow of water and through which water flows continuously or intermittently and includes any ditch, canal, aqueduct or other artificial channel for the conveyance of water to or away from a given place, but not including gutters for storm drainage formed as an integral part of a paved roadway; or any lake, pond, or other surface body of water, fresh or tidal; or other surface area intermittently or permanently covered with water.

- (k) **Local director of health** means the local director of health or his authorized agent.
- (l) **Technical Standards** means the standards established by the Commissioner of Public Health in the most recent revision of the publication entitled "Technical Standards for Subsurface Sewage Disposal Systems" available from the State Department of Public Health.
- (m) **Department** means the State Department of Public Health.
- (n) **Gray water** means domestic sewage containing no fecal material or toilet wastes.
- (o) **Drawdown area** means that area adjacent to a well in which the water table is lowered by withdrawal of water from the well by pumping at a rate not exceeding the recharge rate of the aquifer.

**19-13-B103c. General Provisions**

- (a) All sewage shall be disposed of by connection to public sewers, by subsurface sewage disposal systems, or by other methods approved by the Commissioner of Public Health, in accordance with the following requirements.
- (b) All sewers, subsurface sewage disposal systems, privies and toilet or sewage plumbing systems shall be kept in a sanitary condition at all times and be so constructed and maintained as to prevent the escape of odors and to exclude animals and insects.
- (c) The contents of a septic tank, subsurface sewage disposal system or privy vault shall only be disposed of in the following manner.
  - (1) If the contents are to be disposed of on the land of the owner, disposal shall be by burial or other method which does not present a health hazard or nuisance; or
  - (2) If the contents are to be disposed of on land of other than the owner;
    - (A) The contents shall be transferred and removed by a cleaner licensed pursuant to Connecticut General Statutes Chapter 393a, and
    - (B) Only on the application for and an issuance of a written permit from the local director of health in accordance with the provisions of this section;
  - (3) If the contents are to be dispersed on a public water supply watershed, only on the application and issuance of a written permit by the Commissioner of Public Health in accordance with the provisions of this section.

Each application for a permit under (c) (2) and (3) shall be in writing and designate where and in what manner the material shall be disposed of.

- (d) All material removed from any septic tank, privy, sewer, subsurface sewage disposal system, sewage holding tank, toilet or sewage plumbing system shall be transported in water-tight vehicles or containers in such a manner that no nuisance or public health hazard is presented. All vehicles used for the transportation of such material shall bear the name of the company or licensee and shall be maintained in a clean exterior condition at all times. No defective or leaking equipment shall be used in cleaning operations. All vehicles or equipment shall be stored in a clean condition when not in use. Water used for rinsing such vehicles or equipment shall be considered sewage and shall be disposed of in a sanitary manner approved by the local director of health



- (e) Septic tanks shall be cleaned by first lowering the liquid level sufficiently below the outlet to prevent sludge or scum from overflowing to the leaching system where it could cause clogging and otherwise damage the system. Substantially all of the sludge and scum accumulation shall be removed whenever possible, and the inlet and outlet baffles shall be inspected for damage or clogging. Cleaners shall use all reasonable precaution to prevent damaging the sewage disposal system with their vehicle or equipment. Accidental spillage of sewage, sludge or scum shall be promptly removed or otherwise abated so as to prevent a nuisance or public health hazard.
- (f) No sewage shall be allowed to discharge or flow into any storm drain, gutter, street, roadway or public place, nor shall such material discharge onto any private property so as to create a nuisance or condition detrimental to health. Whenever it is brought to the attention of the local director of health that such a condition exists on any property, he shall investigate and cause the abatement of this condition.

**19-13-B103d. Minimum Requirements**

- (a) Each subsurface sewage disposal system shall be constructed, repaired, altered or extended pursuant to the requirements of this section unless an exception is granted in accordance with the following provisions:
  - (1) A local director of health may grant an exception, except with respect to the requirements of Section 19-13-B103d (d) and Technical Standard IIA, for the repair, alteration, or extension of an existing subsurface sewage disposal system where he determines the repair, alteration or extension cannot be effected in compliance with the requirements of this section and upon a finding that such an exception is unlikely to cause a nuisance or health hazard. All exceptions granted by the local director of health shall be submitted to the Commissioner of Public Health within thirty days after issuance on forms provided by the Department.
  - (2) The Commissioner of Public Health may grant an exception to the requirements of Section 19-13-B103d (d) upon written application and upon a finding that:
    - (A) A central subsurface sewage disposal system serving more than one building is technically preferable for reasons of site limitations, or to facilitate construction, maintenance or future connection to public sewers, or;
    - (B) A subsurface sewage disposal system not located on the same lot as the building served is located on an easement attached thereto. Such easement shall be properly recorded on the land records and shall be revocable only by agreement of both property owners and the Commissioner of Public Health.
  - (3) The Commissioner of Public Health may grant an exception to the requirements of Technical Standard IIA, upon written application and upon a finding that such an exception is unlikely to pollute the well in such a manner as to cause a health hazard.

(b) **Technical Standards.**

Subsurface sewage disposal systems within the scope of this regulation shall be designed, installed and operated in accordance with the technical standards established in the "Technical Standards for Subsurface Sewage Disposal Systems" published by the Commissioner of Public Health. The Technical Standards shall be reviewed annually and changes to the Technical Standards shall be available on January 1st of each year.

(c) **Large Subsurface Disposal Systems.**

The Commissioner of Public Health shall approve plans for subsurface sewage disposal systems serving a building with a designed sewage flow of two thousand gallons per day or greater, and no such systems shall be constructed, repaired, altered or extended unless the plans for such systems are approved by the Commissioner in accordance with the following:

- (1) Plans for the system are submitted at least twenty days prior to approval to construct by the local director of health.
- (2) The plans are designed by a professional engineer registered in the State of Connecticut.
- (3) The plans submitted contain:
  - (A) The basis of design,
  - (B) Soil conditions and test pit locations,
  - (C) Maximum groundwater and ledge rock elevations,
  - (D) Original and finished surface contours and elevations,
  - (E) Property lines, and
  - (F) Locations of buildings, open watercourses, ground and surface water drains, nearby wells and water service lines.

(d) **Location.**

Each building shall be served by a separate subsurface sewage disposal system. Each such system shall be located on the same lot as the building served.

(e) **Disposal of Sewage in Areas of Special Concern.**

- (1) Disposal systems for areas of special concern shall merit particular investigation and special design, and meet the special requirements of this subsection. The following are determined to be areas of special concern:
  - (A) A minimum soil percolation rate faster than one inch per minute, or
  - (B) Slower than one inch in thirty minutes, or
  - (C) Maximum groundwater less than three feet below ground surface, or
  - (D) Ledge rock less than five feet below ground surface, or
  - (E) Soils with slopes exceeding twenty-five per cent, or
  - (F) Consisting of soil types interpreted as having severe limitations for on-site sewage disposal by most recent edition of the National Cooperative Soil Survey of the Soil Conservation Service, or
  - (G) Designated as wetland under the provisions of Sections 22a-36 through 22a-45 of the Connecticut General Statutes, as amended, or
  - (H) Located within the drawdown area of an existing public water supply well with a withdrawal rate in excess of fifty gallons per minute, or within five hundred feet of land owned by a public water supply utility and approved for a future well site by the Commissioner of Public Health.

- (2) In such areas of special concern, the local director of health may require investigation for maximum groundwater level to be made between February 1 and May 31, or such other times when the groundwater level is determined by the Commissioner of Public Health to be near its maximum level.
  - (3) (A) Plans for new subsurface systems in areas of special concern shall:
    - (i) Be prepared by a professional engineer registered in the State of Connecticut;
    - (ii) Include all pertinent information as to the basis of design, and soil conditions, test pit locations, groundwater and ledge rock elevations, both original and finished surface contours and elevation, property lines, building locations, open watercourses, ground and surface water drains, nearby wells and water service lines;
    - (iii) Demonstrate an ability to solve the particular difficulty or defect associated with the area of special concern and which caused its classification. The Commissioner or local director of health, as the case may be, may require a study of the capacity of the surrounding natural soil absorb or disperse the expected volume of sewage effluent without overflow, breakout, or detrimental effect on ground or surface waters if in their opinion such may occur.
  - (B) The plans for new subsurface disposal systems in areas of special concern shall be submitted to the local director of health and the Commissioner of Public Health for a determination as to whether the requirements of the subsection have been met, except that such submission need not be made to the Commissioner of Public Health if the local director or authorized agent has been approved to review such plans by the Commissioner of Public Health in accordance with Section B103e (b). All submissions to the Commissioner of Public Health shall be made at least 20 days prior to issuance of an approval to construct by the local director of health.
  - (4) If application is made for the repair, alteration or extension of an existing subsurface disposal system in an area of special concern, the local director of health may require that the applicant comply with the requirement of Subdivision (3) if he determines that the contemplated repair, alteration or extension involves technical complexities which cannot reasonably be addressed by himself, his authorized agent or the system installer.
  - (5) While a sewage disposal system in an area of special concern is under construction, the local director of health may require that the construction be supervised by a professional engineer registered in the State of Connecticut, if in the opinion of the local director of health it is necessary to insure conformance to the plans approved or because of the difficulties likely to be encountered. The engineer shall make a record drawing of the sewage disposal system, as installed, which he shall submit to the local director of health prior to issuance of a discharge permit.
  - (6) In such areas of special concern, the Commissioner of Public Health or the local director of health who has been approved by the Commissioner to review engineering plans in areas of special concern pursuant to Section 19-13-B103e (b) may require a study of the capacity of the surrounding natural soil to absorb or disperse the expected volume of sewage effluent without overflow, breakout, or detrimental effect on ground or surface waters.
- (f) **Gray Water Systems.**
- Disposal systems for sinks, tubs, showers, laundries and other gray water from residential buildings, where no water flush toilet fixtures are connected, shall be constructed with a septic tank and leaching system at least one-half the capacity specified for the required residential sewage disposal system.

### **19-13-B103e. Procedures and Conditions for the Issuance of Permits and Approvals**

No subsurface sewage disposal system shall be constructed, altered, repaired or extended without an approval to construct issued in accordance with this section. No discharge shall be initiated to a subsurface sewage disposal system without a discharge permit issued in accordance with this section. Such permits and approvals shall be issued and administered by the local director of health.

(a) **No Permit or Approval Shall be Issued:**

- (1) For any subsurface sewage disposal system which is designed to discharge or overflow any sewage or treated effluent to any watercourse;
- (2) For any new subsurface sewage disposal system until it is demonstrated to the satisfaction of the local director of health that there is a public water supply available or a satisfactory location for a water supply well complying with Sections 19-13-B51a through 19-13-B51m of the Public Health Code;
- (3) For any new subsurface sewage disposal system where the soil conditions in the area of the leaching system are unsuitable for sewage disposal purposes at the time of the site investigation made pursuant to this section. Unsuitable conditions occur where the existing soil is impervious, or where there is less than four feet depth of suitable existing soil over ledge rock, two feet of which is naturally occurring soil, or where there is less than 18 inches depth of suitable existing soil over impervious soil, or where the groundwater level is less than 18 inches below the surface of the ground for a duration of one month or longer during the wettest season of the year;
- (4) For any new subsurface sewage disposal system where the surrounding naturally occurring soil cannot adequately absorb or disperse the expected volume of sewage effluent without overflow, breakout or detrimental effect on ground or surface water.

(b) **Approval of Agents by Commissioner of Public Health**

- (1) A local director of health shall authorize only persons approved by the Commissioner of Public Health to investigate, inspect and approve plans relating to subsurface sewage disposal systems.
- (2) The Commissioner of Public Health shall approve agents of the local director of health whose qualifications to investigate, inspect and approve plans relating to subsurface sewage disposal systems have been established by attending training courses and passing examinations given by the Department of Public Health, as follows:
  - (A) Agents who have attended training courses and passed examinations relative to Sections 19-13-B100, 19-13-B103 and 19-13-B104 of the Public Health Code and the Technical Standards shall be approved to investigate, inspect and approve all plans for subsurface sewage disposal systems except those prepared by a professional engineer registered in the State of Connecticut pursuant to Section 19-13-B103d (c) or (e).
  - (B) Agents who have attended training courses and passed examinations relative to the engineering design of subsurface sewage disposal systems shall be approved to investigate, inspect and approve plans for such systems prepared by a professional engineer registered in the State of Connecticut pursuant to Section 19-13-B103d (e).

(c) **Application for Permit or Approval.**

- (1) No investigation, inspection or approval of a subsurface sewage disposal system shall be made, or permit issued without an application by the owner in accordance with the following requirements.
- (2) Applications for permits shall:
  - (A) Be on forms identical to Form #1 in the Technical Standards; or
  - (B) Be on forms prepared by the local director of health and deemed by the Commissioner of Public Health as equivalent to Form #1 in the Technical Standards; and
  - (C) Have attached a plot plan of the lot, which shall be a surveyor's plan if available or one prepared from information on the deed or land records.
- (3) All the requested information shall be provided. If the information is not provided, it shall be indicated why it is not available or the application may be determined incomplete, and be rejected.

(d) **Site Investigation.**

- (1) The local director of health or a professional engineer registered in the State of Connecticut representing the applicant shall make an investigation of the site proposed for the subsurface sewage disposal system and report the findings and recommendations of the investigations on a form identical to Form #2 in the Technical Standards to include:
  - (A) A record of soil test location, measures and observations.
  - (B) Soil percolation results.
  - (C) Observations of groundwater and ledge rock.
  - (D) A conclusion as to the suitability of the site for subsurface sewage disposal.
  - (E) Special requirements for design of the system, or further testing which shall be in accordance with the most recent edition of the Technical Standards.
- (2) Prior to the site investigation, the applicant shall:
  - (A) Provide for the digging of a suitable number of percolation test holes and deep observation pits in the area of the proposed leaching system and extending at least four feet below the bottom of the proposed leaching system, at the direction of the local director of health;
  - (B) Provide water for performing the percolation tests;
  - (C) If required by the local director of health, locate by field stakes or markers the sewage disposal system, house, well or property lines.
- (3) The site investigation shall be made within ten working days of application unless otherwise required by subsection 19-13-B103d (e).

- (4) The local director of health shall:
    - (A) Assure the accuracy of the findings of soil tests and deep observation pits; and
    - (B) When the maximum groundwater level is in doubt the local director of health shall investigate pursuant to Section 19-13-B103d (e).
  - (5) The size of the leaching system shall be based on the results of soil percolation tests made in the area of the proposed leaching system or on other methods of determining the soil absorption capacity in accordance with the Technical Standards.
  - (6) In areas of special concern, or for leaching systems with a design sewage flow of 2,000 gallons per day or greater, the local director of health may require from the applicant whatever further testing or data necessary to assure that the sewage disposal system will function properly. Further testing may be required prior to or subsequent to issuance of the approval to construct. Such tests may include permeability tests, sieve analysis or compaction tests of natural soil or fill materials, and the installation of groundwater level monitoring wells, or pipes, as well as additional observation pits and soil percolation tests.
- (e) **Submission of Plan.**
- (1) Every plan for a subsurface sewage disposal system shall be submitted to the local director of health.
  - (2) Every plan for a subsurface sewage disposal system shall include all information necessary to assure compliance with the requirements of Section 19-13-B103d of these regulations, and contain as a minimum the following information: the location of the house sewer, the location and size of the septic tank, the location and description of the leaching system, property lines, building locations, watercourses, ground and surface water drains, nearby wells and water service lines.
  - (3) Where required by the local director of health under subsections 19-13-B103d (c) and (e) of these regulations, the plan shall be prepared by a professional engineer, registered in the State of Connecticut, and shall be forwarded by the local director to the Commissioner of Public Health, together with his comments and recommendations.
  - (4) No plan shall be submitted directly by the applicant or engineer to the Commissioner of Public Health, unless requested by the local director of health.
- (f) **Approval to Construct.**
- (1) Upon determination that the subsurface sewage disposal system has been designed in compliance with the requirements of Section 19-13-B103d of these regulations, the local director of health shall issue an approval to construct. Approvals to construct shall be valid for a period of one year from the date of their issuance and shall terminate and expire upon a failure to start construction within that period. Approvals to construct may be renewed for an additional one year period by the local director of health upon a demonstration of reasonable cause for the failure to start construction within the one year period.
  - (2) Each subsurface sewage disposal system shall be constructed by a person licensed pursuant to Chapter 393a of the General Statutes. Such person shall notify the local director of health at least twenty-four hours prior to commencement of construction.
  - (3) The Commissioner of Public Health shall approve in accordance with Subsection 19-13-B103d (c) plans for a subsurface sewage disposal system to serve a building, the design sewage flow from which is two thousand gallons a day or greater prior to issuance of an approval to construct by the local director of health.
  - (4) Approval to construct a subsurface sewage disposal system in an area of special concern shall not be issued until twenty days following submission of the plans to the Commissioner of Public Health in accordance with subsection 19-13-B103d (e), unless earlier approved by the Commissioner.

(g) **Inspection.**

- (1) The local director of health shall inspect all subsurface sewage disposal systems for compliance with Subsection 19-13-B103d and the approved plans for construction prior to covering and at such other times as deemed necessary.
- (2) After construction, and prior to covering, the subsurface sewage disposal system installer shall notify the local director of health the site is prepared for inspection. Such inspection shall take place as soon thereafter as feasible, but not later than two (2) working days after receipt of the request unless the owner agrees to an extension.
- (3) A final inspection report shall be prepared by the local director of health on forms deemed by the Commissioner of Public Health as equivalent to Form #3 in the Technical Standards.
- (4) A record plan of the sewage disposal system, as built, shall be required by the local director of health.

(h) **Permit to Discharge.**

- (1) Upon determination that the subsurface sewage disposal system has been installed in compliance with the requirements of Section 19-13-B103d of these regulations and the approved plans, the local director of health shall issue a permit to discharge. A copy of such permit shall be sent to the local building official. No permit to discharge shall be issued until all required forms are completed and an approved as-built plan or record drawing is received.
- (2) Any permit to discharge issued by the Commissioner of Public Health or a local director of health for a household or small commercial subsurface sewage disposal system with a capacity of five thousand gallons per day or less shall be deemed equivalent to a permit issued under Subsection 25-54i(b) of the Connecticut General Statutes. Such permits shall:
  - (A) Specify the manner, nature and volume of discharge;
  - (B) Require proper operation and maintenance of any pollution abatement facility required by such permit;
  - (C) Be subject to such other requirements and restrictions as the Commissioner deems necessary to comply fully with the purposes of this chapter and the Federal Water Pollution Control Act; and
  - (D) Be issued on forms approved by the Commissioner of Public Health.
- (3) The local director of health shall record the granting of an exception from any requirement of Section 19-13-B103d on the permit to discharge.

(i) **Enforcement.**

- (1) A permit to discharge to a subsurface sewage disposal system shall not be construed to permit any sewage overflow, nuisance, or similar condition or the maintenance thereof.
- (2) If such a condition is found to exist, the permit to discharge may be revoked, suspended, modified or otherwise limited and any such condition is subject to an order to abate the condition pursuant to Connecticut General Statutes Section 19-79.

(j) **Records.**

Copies of completed applications, investigation reports, review and inspection forms and as-built plans or record drawings of each sewage disposal system, certified as complying with this Section, shall be kept in the files of the town or health district for a minimum of ten years.

(k) **Rights of Applicant.**

- (1) All site investigations, inspections, review of plans and issuance of permits or approvals by the local director of health shall be made without unreasonable delay.
- (2) When requested in writing by the applicant, the local director of health shall designate in writing within 20 working days the requirement(s) of Section 19-13-B103d or 19-13-B103e of these regulations which prevents such investigation, inspection, review, permit or approval.
- (3) Any final decision of the local director of health made in regard to these sections shall be made in writing and sent to the applicant. Any decision adverse to the applicant or which limits the application shall set forth the facts and conclusions upon which the decision is based. Such written decision shall be deemed equivalent to an order, and may be appealed pursuant to Section 19-103 of the General Statutes.

**19-13-B103f. Non-discharging Sewage Disposal Systems**

- (a) All non-discharging sewage disposal systems shall be designed, installed and operated in accordance with the Technical Standards and the requirements of this section, unless an exception is granted by the Commissioner upon a determination that system shall provide for the proper and complete disposal and treatment of toilet wastes or gray water.

(b) **Composting Toilets.**

- (1) The local director of health may approve the use of a large capacity composting toilet or a heat-assisted composting toilet for replacing an existing privy or failing subsurface sewage disposal system, or for any single-family residential building where application is made by the owner and occupant, and the lot on which the building will be located is tested by the local director of health and found suitable for a subsurface sewage disposal system meeting all the requirements of Section 19-13-B103d of these regulations.
- (2) All wastes removed from composting toilets shall be disposed of by burial or other methods approved by the local director of health.

(c) **Incineration Toilets.**

The local director of health may approve the use of incineration toilets for non-residential buildings or for existing single-family residential dwellings for the purpose of abating existing sewage problems or replacing the existing non-water carriage toilets.

(d) **Chemical Flush Toilets and Chemical Privies.**

- (1) The local director of health may approve chemical flush toilets or chemical privies for nonresidential use where they are located outside of buildings used for human habitation. Chemical flush toilets or chemical privies located inside human habitations shall be approved by the Commissioner of Public Health and the local director of health.
- (2) Liquid waste from chemical flush toilets or chemical privies shall be disposed of in a location and manner approved by the local director of health. Such liquid shall not be disposed of on a public water supply watershed or within five hundred feet of any water supply well unless approved by the Commissioner of Public Health.



(e) **Dry Vault Privies.**

- (1) The local director of health may approve dry vault privies for nonresidential use where they are located outside of buildings used as human habitation.
- (2) Wastes removed from dry privy vaults shall be disposed of by burial or other methods approved by the local director of health.

**STATEMENT OF PURPOSE:**

These regulations up-date existing Public Health Code requirements for the design of subsurface sewage disposal with design flows of 5,000 gallons per day or less and non-discharge toilet systems. Sewage disposal systems conforming to this regulation and designed in compliance with published Technical Standards will provide for the preservation and improvement of public health.

Effective August 16, 1982

**TECHNICAL STANDARDS FOR**  
**SUBSURFACE SEWAGE DISPOSAL SYSTEMS**

**EFFECTIVE AUGUST 16, 1982**  
**REVISED JANUARY 1, 2004**

**I. DEFINITIONS**

- A. Accessory structure** means a permanent non-habitable structure which is not served by a water supply and is used incidental to residential or non-residential buildings. Accessory structures include, but are not limited to, attached and detached garages, covered entryways, screened and enclosed 3-season (non-winterized) porches/sunrooms, open decks, tool and lawn equipment storage sheds, gazebos, barns, etc.
- B. Approved aggregate** means stone aggregate or other product approved by the Commissioner of Public Health for use as backfill material in leaching system construction.
- C. Bedroom** means those areas within a residential building that have the potential to be utilized as a sleeping area on a consistent basis. In order to be deemed a bedroom the room must meet all of the following standards:
1. Be a habitable or planned habitable space per Building Code requirements. Planned habitable spaces would include those areas which contain the appropriate "roughed-in" mechanicals, such as, heating ducts, hot water lines, or plumbing waste lines, etc., but are not currently "finished" to meet Building Code requirements for habitable space.
  2. Provide privacy to the occupants. Large (minimum 5 feet width) openings or archways can be utilized to eliminate room privacy.
  3. Full bathroom facilities (containing either a bathtub or shower) are conveniently located to the bedroom served. Convenience in this case means on the same floor as the bedroom or directly accessed from a stairway.
  4. Entry is from a common area, not through a room already deemed a bedroom.
- D. Building served** means the physical structure that contains the habitable/interior portion of the building connected to the subsurface sewage disposal system. The building served includes any portion of the habitable structure permanently attached to the structure including but not limited to basements and 4-season (winterized) porches/sunrooms. The building served does not include attached accessory structures.
- E. Building sewer** means a sewer pipe extending from the building served to the septic tank or grease interceptor tank. Pipes approved for use under this classification are listed in Table No. 2.
- F. Footing or foundation drains** means those drainage systems, consisting of stone or other free draining material with or without piping, which are installed to collect and redirect groundwater in order to protect below grade portions of a building.
- G. Free draining material** (e.g., gravel, broken stone, rock fragments, etc.) means backfill that meets Department of Transportation Form 814A Specification M.02.07 (or latest specification).
- H. Leaching gallery** means a minimum four-foot wide, level, hollow structure with perforated walls and which is surrounded by approved aggregate on the sides.

- I. Leaching pit** means a hollow, covered structure with perforated sides and which is surrounded on the sides by approved aggregate.
- J. Leaching system** means a structure, excavation or other facility designed to allow settled sewage to percolate into the underlying soil without overflow and to mix with the groundwater. Leaching systems include leaching trenches, leaching galleries, leaching pits, and proprietary leaching systems.
- K. Leaching trench** means a level excavation, not exceeding four feet in width, with vertical sides and flat bottoms filled with approved aggregate and equipped with a single distribution line running the entire length of the excavation.
- L. Proprietary leaching system** means a manufactured product approved by the Commissioner of Public Health to be used as a leaching system.
- M. Select fill** means clean bank run sand, clean bank run sand and gravel, or approved manufactured fill having a gradation which conforms to the specifications stipulated in Section VIII A of the Technical Standards. Note: See Standard VIII A for manufactured fill approval requirements.
- N. Solid pipe** means pipe that has no loose or open joints, perforations, slots or porous openings that would allow seepage to escape from, or water to enter the pipe.
- O. Stone aggregate** means broken stone, crushed stone, or screened gravel meeting Department of Transportation Form 814A Specification M.01.01 for No. 4 stone (as shown below or latest specification). Stone aggregate (previously “one-inch broken stone”) shall be free of silt, dirt or debris and shall show a loss of abrasion of not more than 50% using AASHTO Method T-96.

SIEVE SIZE	PERCENT PASSING (by weight)
2-inch	100
1.5-inch	90 – 100
1-inch	20 – 55
3/4-inch	0 – 10
3/8-inch	0 – 5

- P. Tight Pipe** means those pipes that exhibit both wall strength and watertight joints. Pipes approved for use under this classification are listed in Table No. 2-C.

## II. LOCATION OF SUBSURFACE SEWAGE DISPOSAL SYSTEMS

The following minimum separating distances are required and shall be maintained between any part of a subsurface sewage disposal system and the items listed below. Tables No. 2 through 2-D list specific applications whereby specified piping may encroach less than the distances stated below:

**TABLE NO. 1**

ITEM	SEPARATING DISTANCE	SPECIAL PROVISIONS
A. Well (potable, geothermal, irrigation), spring or domestic water suction pipe.  <u>Required withdrawal rate</u> under 10 gal. per minute 10 to 50 gal. per minute over 50 gal. per minute	75 feet 150 feet 200 feet	(1) Separation distance shall be doubled where the soil has a minimum percolation rate faster than one minute/inch and there is less than 8 feet between the bottom of the proposed leaching system and ledge rock. Doubling of the separation distance will be waived if a minimum of 4 feet of slower than one minute/inch naturally occurring soils are found between the bottom of the leaching system and ledge. (2) Separation distance shall be increased as necessary to protect the sanitary quality of a public water supply well
B. Human habitation on adjacent property	15 feet	Building shall have no footing drains
C. Building served	15 feet	Building shall have no footing drains. Distance to a septic tank septic tank/pump chamber/grease interceptor tank may be reduced to a minimum of 10 feet
D. Open watercourse	50 feet	When not located on a public water supply watershed, this distance shall be reduced as necessary to not less than 25 feet on lots in existence prior to the effective date of this regulation and thereafter recorded as required by statute
E. Public water supply reservoir	100 feet	
F. Surface or groundwater drain constructed of solid pipe	25 feet	Tight pipe with rubber gasketed joints or accepted equal (see Table 2-C) are exempted from this requirement as long as the pipe excavation is not backfilled with free draining material, however no tight pipe shall be less than 5 feet from system. Leakage tests may be required to verify water tightness.
G. Groundwater intercepting drains, footing or foundation drain located up-gradient from sewage disposal system	25 feet	
H. Any down gradient drainage system, installed to collect and redirect groundwater, such as, loose or open jointed, perforated, slotted or pervious pipe drains, or piping backfilled with free draining material, located down gradient from a sewage disposal system	50 feet	(1) No such drain shall be constructed down gradient from the leaching system on the same property for the purpose of collecting sewage effluent no matter what the separating distance (2) The location of a septic tank/pump chamber/grease interceptor tank may be reduced to a minimum of 25 feet if determined to be watertight (For concrete tanks in accordance with Sec. 9.2 of ASTM C-1227) See Standard V A 6.
I. Top of embankment	10 feet	Down gradient and all sides Cuts within 50 feet down gradient of leaching systems shall not be allowed if bleed-out conditions are possible
J. Property line	10 feet	
K. Potable water and/or irrigation lines which flow under pressure	10 feet	
L. Below ground swimming pool	25 feet	
M. Above ground swimming pool	10 feet	Includes hot tubs
N. Accessory structure	10 feet	Structure shall have no footing drains Structures without full wall, frost protected footings may be reduced to a minimum of 5 feet
O. Utility service trench (Underground electric, gas, phone services, etc.)	5 feet	Excavations between 5 – 25 feet from system shall not be backfilled with free draining material

**Record Plans:** Following system installation and inspection a record plan of the sewage system, as built, must be prepared. The record plan must locate access points (tank cleanouts, distribution boxes, etc) and leaching system ends. Drawing can be a plan to scale or a tie plan from two or more permanent reference points. Tie plans must note distance between reference points. A licensed installer shall prepare and submit the record plan unless an engineered record drawing is required by local director of health in accordance with PHC 19-13-B103d (e)(5).

### III. PIPING

#### A. Building sewers

Building sewers shall be not less than four inches in diameter. The grade shall be at least one-quarter inch per foot for four-inch sewers and shall not be less than one-eighth inch per foot for six or eight inch sewers. Building sewers shall be laid with tight joints to the septic tank or grease interceptor tank, and in a straight line and on a uniform grade wherever possible. Accessible manholes or surface cleanouts shall be provided at one or more cumulative changes of directions exceeding 45° (see Figure No. 1), unless a 90° sweep type piping approved in Table 2 is utilized. Accessible manholes or surface cleanouts shall be provided for each 75 feet length of building sewer from foundation wall to the septic tank or grease interceptor tank. Pipe for such sewers shall be of cast iron with rubber gasketed joints or accepted equal\* to a point at least twenty-five feet beyond the foundation wall of any cellar or basement. Portions of building sewers within seventy-five feet of a well shall be of cast iron with rubber gasketed joints or accepted equal\*, but no portion of such sewer, however constructed, shall be within twenty-five feet of a well. No sewer shall be located within twenty-five feet of a cellar drain or ground or surface water drain unless the pipe is of cast iron with rubber gasketed joints or accepted equal\*. Long sewer lines shall be avoided to reduce the danger of groundwater infiltration, and sewer blockages.

\*See Tables No. 2 through 2-C

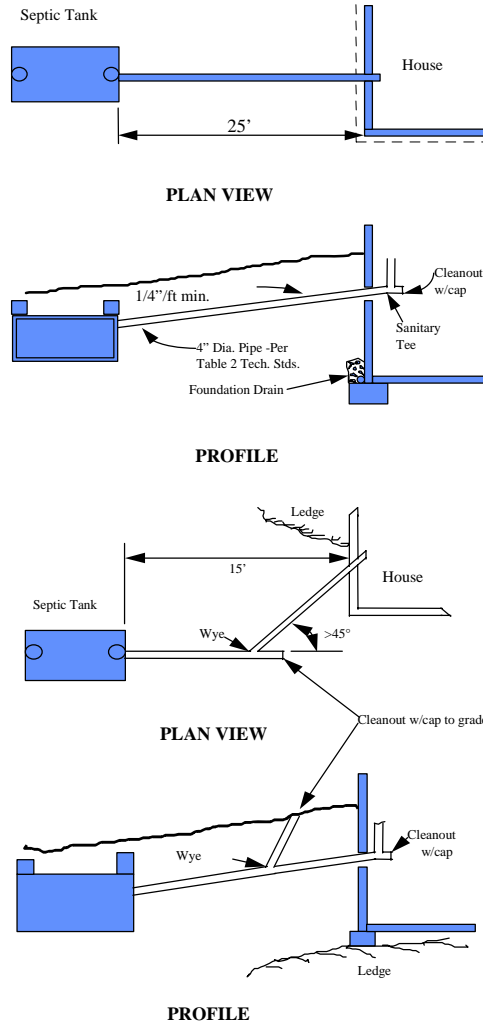

**FIGURE NO. 1 - BUILDING SEWERS**

**TABLE NO. 2  
ACCEPTED BUILDING SEWER PIPE FOR USE FROM FOUNDATION WALL TO SEPTIC TANK**

NOTE: The local director of health or authorized agent prior to covering shall visually inspect all sewer lines and joints

USE	PIPE DESCRIPTION	ACCEPTABLE JOINT	REMARKS
<p>Building sewer from foundation wall to septic tank or grease interceptor tank, within 25 feet of building served</p> <p>Building sewer line within 75 feet of a private water supply well, spring or water suction pipe <u>but no closer than 25 feet</u> for wells with withdrawal rates less than 10 gpm. Greater separation distances required for wells with withdrawal rates 10 gpm or greater (see PHC 19-13-B51d)</p> <p>NOTE: Building sewer may cross potable water lines under pressure.</p> <p>To reduce separation distances for the <u>following other items listed in Table No. 1:</u></p> <ul style="list-style-type: none"> <li>-Human habitation on adjacent property</li> <li>-Building served</li> <li>-Top of embankment</li> <li>-Property line</li> <li>-Pressure water lines</li> <li>-Swimming pools</li> <li>-Accessory structures</li> <li>-Utility service trench</li> </ul>	<p>Cast iron hubless ASTM A-888</p>	<p>Cast iron split sleeve bolted joint with rubber gasket, MG coupling or equal</p> <p align="center">OR</p> <p>3"-wide, heavy -duty, stainless steel banded coupling with rubber gasket; clamp-all, ANACO SD 4000, or equal</p>	<p>Roll-on "donut type" gaskets not acceptable if connection is within 25 feet of foundation wall. Pipe must be properly bedded, laid in straight line on uniform grade</p> <p>FERNCO - stainless steel 3" wide shear band allowed for connection of dissimilar piping materials</p>
	<p>Cast iron bell and spigot ASTM A-74</p>	<p>Rubber compression gaskets</p>	<p>*Use of 3"-wide approved stainless steel banded couplings on PVC Schedule 40 ASTM D 1785 is acceptable</p> <p>UL (gray) Piping - Schedule 40-36" radius- may be utilized as 90° sweep without the need for cleanouts.</p> <p>ABS Schedule 40 is not acceptable</p>
	<p>PVC ASTM D 1785 /ASTM D 2665, Schedule 40</p>	<p>Rubber compression gasket couplings, Harco Mfg., ASTM D 3139 or equal*</p> <p align="center">OR</p> <p>Solvent weld couplings/ fittings using proper two step PVC solvent solution procedure</p>	<p>Connection to cast iron building sewer must be made with compression gaskets.</p>
	<p>Ductile iron ANSI A 21.51</p>	<p>Rubber compression gaskets</p>	<p>"O"-ring gasket is not acceptable</p>
	<p>PVC AWWA C-900 (PC 100 psi min.)</p>	<p>Rubber compression gaskets</p>	<p>Only 4" pipe approved</p> <p>Minimum 1' cover in vehicular loaded traffic areas</p>
	<p>PVC ASTM F 1760, Schedule 40</p>	<p>Rubber compression gaskets</p>	

**TABLE 2-A**  
**ACCEPTED SEWER PIPE FOR INSTALLING SEWER CONNECTIONS TO PUBLIC SEWERS**  
**WITHIN 75 FEET OF PRIVATE WATER SUPPLY WELLS**

NOTE: All building sewer lines installed within 75 feet but no closer than 25 feet of a private well should be inspected and approved by the local director of health or sewer inspector prior to back filling

USE	PIPE DESCRIPTION	ACCEPTABLE JOINT	REMARKS
Building sewer connection to public sewers or other sewer lines within 75 feet of a private water supply well, spring, or water suction pipe serving a single-family dwelling. No sewer line shall be located within 25 feet of a private well.  Note: <u>Greater</u> separating distances are required for wells with withdrawal rates 10 GPM or greater (See PHC 19-13-B51d)	Cast iron hubless ASTM A-888	Cast iron split sleeve bolted connector with rubber gasket, MG coupling or equal to 3" wide, heavy-duty stainless steel banded coupling with rubber gasket; Clamp-all, ANACO SD 4000, or equal	Roll-on "donut type" gaskets not acceptable if used within 75 feet of well. Pipe must be properly bedded in accordance with pipe manufacturer's specifications, laid in a straight line on a uniform grade
	Cast iron bell and spigot ASTM A-74	Rubber compression gaskets	
	Ductile iron ANSI A21.51	Rubber compression gasket	
	Extra strength PVC pressure water pipe AWWA C-900 (PC 100 psi min.)	Rubber compression gasket	
	PVC ASTM D 1785 /ASTM D 2665, Schedule 40  PVC ASTM D 2241, SDR 21  PVC ASTM F 1760, Schedule 40 or SDR 35  PVC ASTM D 3034, SDR 35 PVC ASTM F 789 PVC ASTM F 679	Rubber compression gasketed couplings, Harco Mfg., ASTM D 3139 or equal  OR Solvent weld couplings/ fittings using proper two step PVC solvent solution procedure  Integral rubber compression gaskets or roll-on compression gaskets	Use of 3" wide approved stainless steel banded couplings on PVC Schedule 40 ASTM D 1785 is acceptable  ABS Schedule 40 is not acceptable  Joints must meet ASTM D 3212 specifications  Bedding in accordance with ASTM D 2321 for PVC pipe

**TABLE 2-B  
ACCEPTED SEWER PIPE FOR USE IN CONSTRUCTING PUBLIC SEWER LINES  
WITHIN 75 FEET OF PRIVATE WATER SUPPLY WELL**

NOTE: All public sewer lines installed within 75 feet but no closer than 25 feet of private wells serving single-family residences should be low pressure air tested in the presence of the design engineer who should submit a report of the test results to the local director of health.

USE	PIPE DESCRIPTION	ACCEPTABLE JOINT	REMARKS
<p>Public sewer line within 75 feet of a private water supply well, spring or water suction pipe serving single-family residences <u>but no closer than 25 feet.</u></p> <p>Note: <u>Greater</u> separating distances are required for wells with withdrawal rates 10 GPM or greater (See PHC 19-13-B51d)</p>	Cast iron hubless pipe ASTM A-888	Cast iron split sleeve bolted connector with rubber gasket MG coupling or equal or 3"-wide heavy duty stainless steel banded coupling with rubber gasket; Clamp-All ANACO SD 4000 or equal	<p>Roll-on "donut type" gaskets not acceptable if used within 75 feet of well. Pipe must be properly bedded, in accordance with pipe manufacturer's specifications, laid in a straight line on a uniform grade</p>
	Cast iron bell and spigot ASTM A-74	Rubber compression gaskets	
	Ductile iron ANSI A21.51	Rubber compression gaskets	
	Extra strength PVC pressure water pipe AWWA C-900 (PC 100 psi min.)	Rubber compression gaskets	
	Reinforced concrete water pipe, steel cylinder type, pre-stressed AWWA C-301	Rubber compression gaskets	
	Reinforced concrete water pipe, steel cylinder type, not pre-stressed AWWA C-300	Rubber compression gaskets	
	<p>PVC ASTM D 1785 /ASTM D 2665, Schedule 40</p> <p>PVC ASTM D 2241, SDR 21</p> <p>PVC ASTM F1760, Schedule 40 or SDR 35</p> <p>PVC ASTM D 3034, SDR 35</p> <p>PVC ASTM F 789</p> <p>PVC ASTM F 679</p>	<p>Rubber compression gasketed couplings, Harco Mfg., ASTM D3139 or equal*</p> <p align="center">OR</p> <p>Solvent weld couplings/fittings using proper two step PVC solvent solution procedure</p>	<p>*Use 3"-wide stainless steel banded couplings on PVC Schedule 40 ASTM D 1785 is acceptable</p> <p>ABS Schedule 40 is not acceptable</p> <p>Joints must meet ASTM D 3212.</p> <p>Bedding in accordance with ASTM D 2321 for PVC pipe</p>



**TABLE 2-C  
ACCEPTED TIGHT PIPE FOR USE WITHIN 25 FEET OF WATERCOURSE AND DRAINS  
OR CLEAN WATER DRAIN WITHIN 25 FEET OF SEWAGE DISPOSAL SYSTEMS**

USE	PIPE DESCRIPTION	ACCEPTABLE JOINT	REMARKS			
<p>PRIVATE building sewer or effluent distribution line within 25 ft. of any open watercourse, surface or groundwater drain, cellar, footing or foundation drain. and ground and surface water drainage pipes within 25 ft of a subsurface sewage disposal system</p> <p>To reduce separation distances for the following other items listed in <u>Table No. 1:</u></p> <ul style="list-style-type: none"> <li>-Human habitation on adjacent property</li> <li>-Building served</li> <li>-Top of embankment</li> <li>-Property line</li> <li>-Pressure water lines</li> <li>-Swimming pools</li> <li>-Accessory structures</li> <li>-Utility service trench</li> </ul>	Cast iron hubless pipe ASTM A-888	Cast iron split sleeve bolted connector with rubber gasket MG coupling or 3"-wide, heavy duty stainless steel banded coupling with rubber gasket; Clamp-All ANACO SD 4000 or equal	Roll-on "donut type" gaskets not acceptable if used within 25 ft. of watercourse. Pipe must be properly bedded in accordance with manufacturer's specifications, laid in a straight line on a uniform grade			
	Cast iron bell and spigot ASTM A-74	Rubber compression gaskets				
	Ductile iron ANSI A21.51	Rubber compression gaskets				
	Extra strength PVC pressure water pipe AWWA C-900 (PC 100 psi min.)	Rubber compression gaskets				
	Reinforced Concrete Pipe ASTM C 76	Rubber compression gaskets, ASTM C 443				
	Reinforced concrete water pipe, steel cylinder type, AWWA C-300/ C-301	Rubber compression gaskets				
	PVC ASTM D 1785/ ASTM D 2665, Schedule 40	Rubber compression gasketed couplings, Harco Mfg., ASTM D3139 or equal* or Solvent weld couplings/fittings using proper two step PVC solvent solution procedure		*Use of 3"-wide approved stainless steel banded couplings on PVC ASTM D 1785 Schedule 40 is acceptable		
	PVC ASTM D 2241, SDR 21			ABS Schedule 40 is not acceptable		
	PVC ASTM F1760, SDR 35 PVC ASTM D 3034, SDR 35 PVC ASTM F 789 PVC ASTM F 679	Rubber compression gaskets or Solvent weld couplings/fittings using proper two step PVC solvent solution procedure		Joint must meet ASTM D 3212 specifications. Stone bedding is not allowed		
PE, ADS N-12, ASTM F 667, AASHTO M-294, 24-inch maximum diameter	Series 35 ADS coupling, o-ring gasket or WT Pipe/joint (Gasketed bell/spigot)	Coupling: ASTM D 3034/F 1336 Joints (Coupling and WT) meet ASTM D 3212				
PE, Hancor Blue Seal, ASTM F 667, AASHTO M-294, 24-inch maximum diameter		Blue Seal coupling/rubber compression gasket	Joint meets ASTM D 3212			

**TABLE 2-D****ACCEPTED SEWER PIPE FOR USE AS SEWER FORCE MAIN FOR SPECIFIC APPLICATIONS**

USE	PIPE DESCRIPTION	ACCEPTABLE JOINT	REMARKS
<p>Sewage force main within 75 ft. of a private water supply well, spring or water suction pipe (no sewer line shall be located within 25 ft. of private well). Greater separating distances required for 10 gpm or more wells (see PHC 19-13-B51d)</p> <p style="text-align: center;">OR</p> <p>Sewage force main within 25 ft. of a open watercourse, surface or groundwater drain, footing or foundation drain.</p> <p>To reduce separation distances for the <u>following other items listed in Table No. 1:</u></p> <ul style="list-style-type: none"> <li>- Human habitation on adjacent property</li> <li>-Building served</li> <li>-Top of embankment</li> <li>-Property line</li> <li>-Pressure water lines</li> <li>-Swimming pools</li> <li>-Accessory structures</li> <li>-Utility service trench</li> </ul>	PVC pressure pipe ASTM D 2241, SDR 21, SDR 17, or SDR 13.5	Bell and spigot with compression rubber gaskets	
	PVC pressure water pipe AWWA C-900 (PC 200 psi minimum)		
	PVC ASTM D 1785 / ASTM D 2665, Schedule 40	Solvent welded, threaded joints or gasketed couplings	
	PE ASTM D 2239 PE ASTM D 2737	No joints within 75 ft. of well or 25 ft. of open watercourse, ground or surface water drains	

## B. Water pipe trenches

Whenever possible, pressurized water service mains and building sewer lines shall be located in separate trenches at least ten feet apart. Where laid in the same trench, the water pipe shall be laid on a bench at least eighteen inches above the top of the sewer pipe and at least twelve inches, and preferably eighteen inches, from the side of the sewer trench (see Figure No. 2). However, in no case shall a building sewer pipe be located less than seventy-five feet from water suction pipe unless approved piping is used (See Table No. 2).

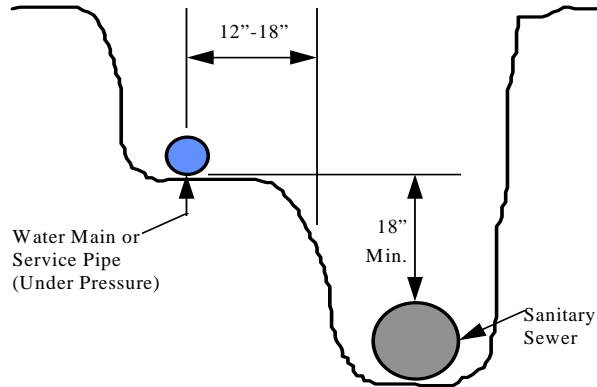

**FIGURE NO. 2 - WATER PIPE TRENCHES**

When it is necessary to cross a private pressurized water service line with a pipe serving a subsurface sewage disposal system, the pipe shall be listed either in Table 2 or Table 2-C. Table 2 will apply when the water service is located below the sewer pipe. Table 2-C will apply when the water service is located above a sewer. Sewer force mains listed in Table 2-D may cross over or under pressurized water service lines.

## C. Procedure for Air Pressure Testing of Sewer Pipe

1. Test is conducted between two (2) consecutive manholes, as directed by the engineer.
2. The test section of the sewer line is plugged at each end. One of the plugs used at the manhole must be tapped and equipped for the air inlet connection for filling the line from the air compressor.
3. All service laterals, stubs and fittings into the sewer test section should be properly capped or plugged, and carefully braced against the internal pressure to prevent air leakage by slippage and blowouts.
4. Connect air hole to tapped plug selected for the air inlet. Then connect the other end of the air hose to the portable air control equipment which consists of valves and pressure gages used to control:
  - a) the air entry rate to the sewer test section, and
  - b) to monitor the air pressure in the pipe line.

More specifically, the air control equipment includes a shut-off valve, pressure regulating valve, pressure reduction valve and a monitoring pressure gage having a pressure range from 0 to 5 psi. The gage should have minimum divisions of .10 psi and an accuracy of  $\pm 0.04$  psi. Figure No. 3 illustrates diagrammatically a typical control equipment apparatus.

5. Connect another air hose between the air compressor (or other source of compressed air) and the air control equipment. This completes the test equipment set-up. Test operations may commence.
6. Supply air to the test section slowly, filling the pipe line until a constant pressure of 3.5 psig is maintained. The air pressure must be regulated to prevent the pressure inside the pipe from exceeding 5.0 psig.
7. When constant pressure of 3.5 psig is reached, throttle the air supply to maintain the internal pressure above 3.0 psig for at least 5 minutes. This time permits the temperature of the entering air to equalize with the temperature of the pipe wall. During this stabilization period, it is advisable to check all capped and plugged fittings with a soap solution to detect any leakage at these connections.

If leakage is detected at any cap or plug, release the pressure in the line and tighten all leaky caps and plugs. Then start the test operation again by supplying air. When it is necessary to bleed off the air to tighten or repair a faulty plug, a new 5-minute interval must be allowed after the pipe line has been refilled.

8. After the stabilization period, adjust the air pressure to 3.5 psig and shut off or disconnect the air supply. Observe the gage until the air pressure reaches 3.0 psig. At 3.0 psig, commence timing with a stop watch which is allowed to run until the line pressure drops to 2.5 psig at which time the stop watch is stopped. The time required, as shown on the stopwatch, for a pressure loss of 0.5 psig is used to compute the air loss. Most authorities consider it unnecessary to determine the air temperature inside the pipe line and the barometric pressure at the time of the test.
9. If the time, in minutes and seconds, for the air pressure to drop from 3.0 to 2.5 psig is greater than that shown on Table No. 3 for the designated pipe size, the section undergoing test shall have passed and shall be presumed to be free of defects. The test may be discontinued at that time.
10. If the time, in minutes and seconds, for the 0.5 psig drop is less than that shown in Table No. 3 for the designated pipe size, the section of pipe shall not have passed the test; therefore, adequate repairs must be made and the line retested.

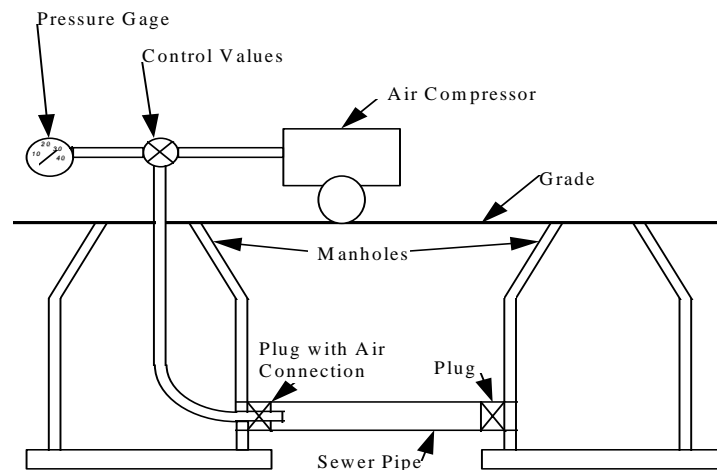

**FIGURE NO. 3 - TYPICAL AIR TEST EQUIPMENT LAYOUT**

**TIME REQUIREMENTS FOR AIR TESTING**

PIPE SIZE (INCHES)	TIME	
	MINUTES	SECONDS
4	2	32
6	3	50
8	5	06
10	6	22
12	7	39
14	8	56
15	9	35
16	10	12
18	11	34
20	12	45
21	13	30

(For larger diameter pipe use the following: Minimum time in seconds = 462 X pipe diameter in ft)

**TABLE NO. 3**

10. (Continued)

- a) Pipe sizes with their respective Recommended Minimum Times, in Minutes and Seconds, for Acceptance by the Air Test Method.
- b) For eight (8) inch and smaller pipe, only: if, during the 5-minute saturation period, pressure drops less than 0.5 psig after the initial pressurization and air is not added, the pipe section undergoing tests shall have passed.
- c) Multi Pipe Sizes: When the sewer line undergoing test is 8" or larger diameter pipe and includes 4" or 6" laterals, the figures in Table 3 for uniform sewer main sizes will not give reliable or accurate criteria for the test. Where multi-pipe sizes are to undergo the air test, the engineer can compute the "average" size in inches which is then multiplied by 38.2 seconds. The results will give the minimum time in seconds acceptable for a pressure drop of 0.5 psig for the "averaged" diameter pipe.

#### IV. DESIGN FLOWS

**RESIDENTIAL BUILDINGS:** 150 Gallons per Day per Bedroom

**NON-RESIDENTIAL BUILDINGS and RESIDENTIAL INSTITUTIONS:** Table No. 4 shall be used for determining the daily design flow from non-residential buildings and residential institutions unless specific water use data is available for the facility. Design flow based on metered flows must use a minimum 1.5 safety factor applied to all metered average daily water use.

**TABLE NO. 4**

<b><u>SCHOOLS, PER PUPIL</u></b>	<b><u>GALLONS PER DAY</u></b>
BASE FLOW (EXCLUDES KITCHEN & SHOWERS)	
HIGH SCHOOL	12
JR. HIGH/MIDDLE SCHOOL	9
KINDERGARTEN/ELEMENTARY SCHOOL	8
KITCHEN	3
SHOWERS	3 to 5
RESIDENTIAL	100
DAY CARE CENTER (NO MEALS PREPARED)	10
<b><u>COMMERCIAL/INDUSTRIAL BUILDINGS, PER EMPLOYEE</u></b>	
FACTORY (NO SHOWERS)	25
FACTORY (WITH SHOWERS)	35
OFFICE (AVERAGE 200 SQ.FT./PERSON-GROSS AREA)	20
SMALL RETAIL BUILDING-LESS THAN 2,000 SQ.FT.-GROSS AREA	20
LARGE RETAIL/COMMERCIAL BUILDING-SEE MISCELLANEOUS	
<b><u>CAMPS</u></b>	
RESIDENTIAL CAMPS (SEMI PERMANENT), PER PERSON	50
CAMPGROUND WITH CENTRAL SANITARY FACILITIES, PER PERSON	35
CAMPGROUND WITH FLUSH TOILETS (NO SHOWERS), PER PERSON	25
CAMPGROUNDS PER CAMP SPACE (WATER AND SEWER HOOK-UPS)	75
DAY CAMPS, PER PERSON	15
LUXURY CAMPS, PER PERSON	75
PICNIC PARKS (TOILET WASTES ONLY), PER PERSON	5
PICNIC PARKS WITH BATHHOUSES, SHOWERS, FLUSH TOILETS, PER PERSON	10
<b><u>HEALTH CARE FACILITIES</u></b>	
HOSPITALS, PER BED	250
REST HOMES, PER BED	150
CONVALESCENT HOMES, PER BED	150
INSTITUTIONS, PER RESIDENT	100
GROUP HOME, PER CLIENT (LARGE TUB/ON-SITE LAUNDRYING USE HIGHER FLOW)	100-150
<b><u>RESTAURANTS</u></b>	
RESTAURANTS (PUBLIC TOILETS PROVIDED), PER MEAL SERVED	10
TAKE OUT FOOD SERVICE/RESTAURANTS WITH NO PUBLIC TOILETS, PER MEAL SERVED	5
BARS AND COCKTAIL LOUNGES (NO MEALS) PER PATRON	5
<b><u>RECREATIONAL FACILITIES</u></b>	
SWIMMING POOLS, PER BATHER	10
INDOOR TENNIS COURTS, PER COURT	400
OUTDOOR TENNIS COURTS, PER COURT	150
THEATERS, SPORTING EVENTS, PER SEAT	3.5
<b><u>CHURCHES</u></b>	
WORSHIP SERVICE ONLY, PER SEAT	1
SUNDAY SCHOOL, PER PUPIL	2
SOCIAL EVENTS (MEALS SERVED) PER PERSON	5
<b><u>MISCELLANEOUS</u></b>	
AUTO SERVICE STATIONS, PER CARS SERVICED	5
BEAUTY SALON, PER CHAIR	200
BARBER SHOPS, PER CHAIR	50
DENTAL/MEDICAL OFFICES WITH EXAMINATION ROOMS, PER SQ. FT. OF GR. AREA	0.2
KENNEL DOG RUNS, PER RUN, ROOF MUST BE PROVIDED	25
LARGE RETAIL/COMMERCIAL BLDG., PER SQ. FT. OF GROSS AREA	0.1
LAUNDROMATS, PER MACHINE	400
MOTELS, PER ROOM, (NO FOOD SERVICE, KITCHENETTE OR LAUNDRY FACILITIES)	75
MOTELS, PER ROOM, (WITH KINCHENETTE BUT NO LAUNDRY FACILITIES)	100
MARINAS (BATHHOUSE-SHOWERS PROVIDED), PER BOAT SLIP	20

## V. SEPTIC TANKS

### A. General

#### 1. **Septic Tank Standards**

All subsurface sewage disposal systems shall be provided with a septic tank. Such septic tank shall be made of concrete or other durable material approved by the Commissioner of Public Health.

##### a) Concrete Septic Tanks

All concrete septic tanks shall be produced with a minimum 4,000-psi concrete with 4 to 7 percent air entrainment. Concrete tanks must not be shipped until the concrete has reached the 4,000-psi compressive strength. Concrete septic tank construction shall conform to ASTM C 1227 with the following exceptions:

- There shall be no maximum liquid depth.
- The air space above the liquid level shall be a minimum of eight inches.
- Inspection ports over the compartment wall shall be optional.

##### b) Non-Concrete Septic Tanks

All non-concrete septic tanks shall meet all of the applicable requirements set forth in subsections 2, 3, and 4 of Standard V A regarding tank configuration, tank access, and tank cleaning. Non-concrete tanks shall be marked with the manufacturer's name and tank designation number. Non-concrete septic tanks shall be installed with strict adherence to the manufacturer's installation instructions in order to avoid tank damage or tank deformation. Proper bedding, backfill, and compaction shall be confirmed with each tank installation. Shallow groundwater conditions may prohibit installation of certain tanks due to tank design limitations or warranty restrictions. Tank bottoms located below maximum groundwater levels must be provided with anti buoyancy/floatation provisions (check with manufacturer). Manufacturers of non-concrete septic tanks shall file specifications and technical support documentation with the Commissioner of Public Health. The Commissioner of Public Health shall maintain a list of approved non-concrete septic tanks. The approved list as of the date of this revision has been provided in Appendix D.

#### 2. **Tank Configuration**

All septic tanks shall contain an inlet baffle submerged for a depth of eight to eighteen inches and an outlet baffle (unless tank is provided with an approved outlet filter) submerged to a depth of at least ten inches, but no lower than 40 percent, of the liquid depth. The inlet baffle shall encompass not more than 48 square inches of liquid surface area. All baffles shall extend a minimum of five inches above the tank's liquid level and an air space of at least a 1/2-inch shall be provided above the baffle. The outlet invert of the septic tank shall be 3 inches lower than the inlet invert. Tanks must be installed with the inlet invert between 2 and 4 inches above the outlet invert. Inlet and outlet piping entering and exiting the septic tank shall be as level as possible with a pitch no greater than 1/4-inch per foot. The outlet invert of the tank shall be set at a higher elevation than the top of all leaching structures (except in a pump systems), or in the case of serial systems higher than the high-level overflow elevation of the upper most trench. All newly installed tanks shall have an approved non-bypass effluent filter at the outlet. The Commissioner of Public Health shall maintain a list of approved outlet filters. The approved list as of the date of this revision has been provided in Appendix B.

All septic tanks (except tanks in series) shall have two compartments with 2/3 of the required capacity in the first compartment (see Figure No. 4). The transfer port must be at mid-depth (opening in middle 25% of liquid depth). Inlet and outlet piping shall be sealed with a polyethylene gasket or rubber boot with stainless steel clamp. All septic tanks shall be manufactured with

manhole covers or risers that have been placarded with notification of its two-compartment construction and a warning that "Entrance into the tank could be fatal". The minimum liquid depth of septic tanks shall be thirty-six inches.

Additional septic tank capacity over one thousand gallons may be obtained by utilizing two tanks in series. In no case may more than two septic tanks be placed in series. When two septic tanks are placed in series, each tank shall be of single compartment design; the volume of the first tank shall be twice the volume of the second; mid-depth baffles shall be provided at the connection of the two tanks; an outlet filter shall be provided for the outlet of the second tank (see Figure No. 5).

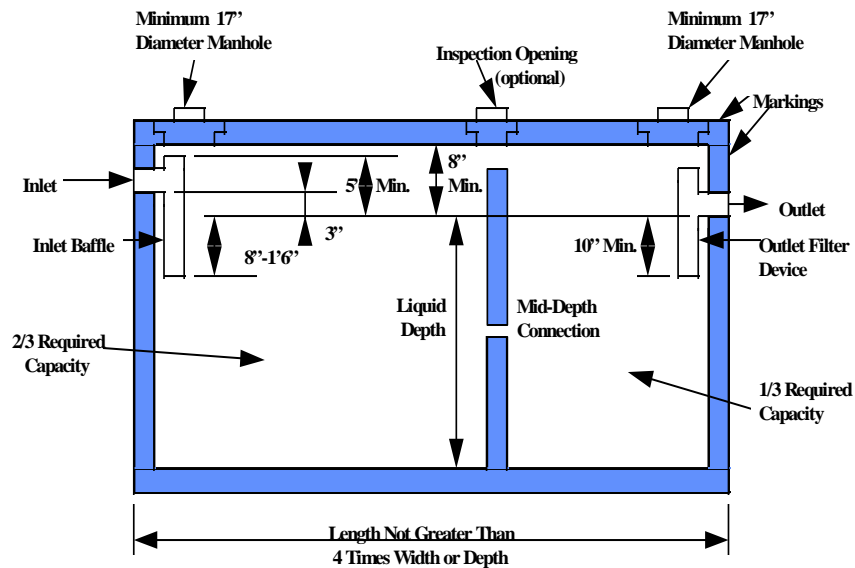

**FIGURE NO. 4 - TYPICAL SEPTIC TANK**

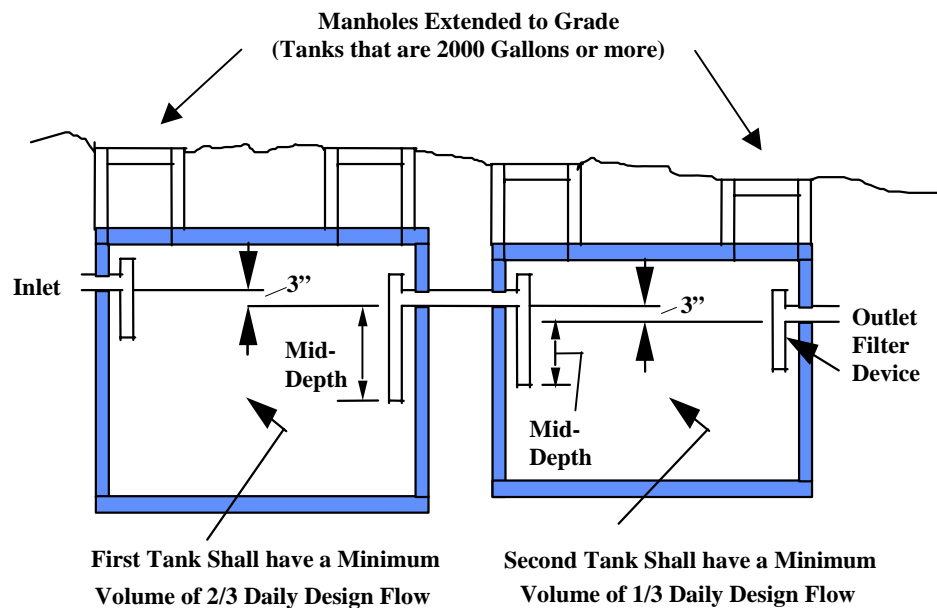
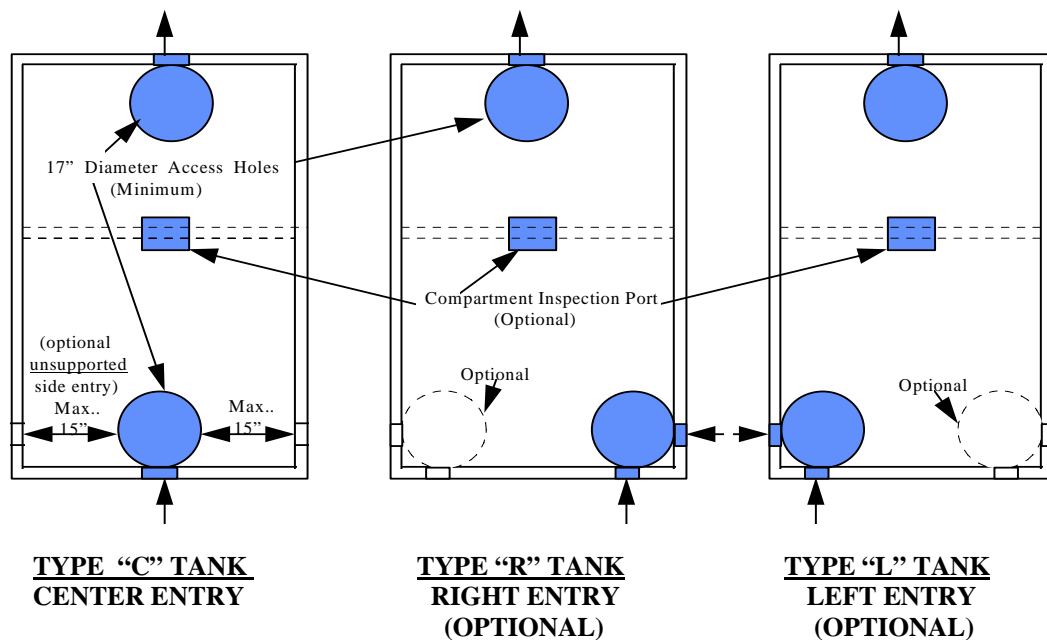

**FIGURE NO. 5 - SEPTIC TANKS IN SERIES**



### 3. Septic Tank Access

Septic tanks shall have removable covers or manholes to provide access to the tank for the purposes of inspection and cleaning. Cleanout manholes shall be located at a depth not greater than twelve inches below final grade level. Existing tanks that exceed the 12-inch depth shall be retrofitted with a cleanout riser(s) at the time of tank cleaning. New tanks and existing tanks deeper than 24 inches below finish grade shall be provided with large (24-inch minimum inside diameter) access risers over each manhole opening. Cleanouts shall consist of a minimum 17-inch inside diameter opening and shall be located directly over the inlet baffle and outlet filter. If a tank provides side inlets, the maximum distance between the interior wall surface and the cleanout manhole shall be 15 inches unless the pipe extension from the tank side to the cleanout manhole opening will be supported. Baffle extensions shall not have more than a 1/4-inch per foot pitch. All tank covers shall be stepped and be provided with handles consisting of 3/8-inch coated rebar or approved plastic handles. Below ground plastic handles and plastic riser covers cannot be used unless provisions are made to allow for manhole locating with a metal detector. On septic tanks of two thousand gallons or more, manholes shall extend to grade except for single-family residential buildings. Where covers are flush with or above grade, either the lid must weigh a minimum of 59 pounds or the cover shall be provided with a lock system to prevent unauthorized entrance. Tanks that exceed fifteen feet in length shall provide a minimum of three manholes. In any case, the overall length shall not be greater than four times either the width or the depth.



### STANDARDIZED SEPTIC TANK TOP CONFIGURATIONS

### 4. Septic Tank Cleaning

Septic tanks shall be cleaned as often as necessary to prevent a buildup of sludge, grease and scum which will adversely effect the performance of the leaching system. In a properly functioning subsurface sewage disposal system, effluent should not backflow from the leaching system into the septic tank at the time of pumping. Such conditions indicate the leaching system is surcharged at that time. In these instances, further system evaluation is warranted. Inlet and outlet baffles shall be inspected for damage or clogging at the time of the tank pump out. When provided, outlet filters shall be properly cleaned, at the time of each tank pump out, by washing the filter waste into the septic tank or, if rinse water is not available, exchanged with a clean filter. All contaminated filters shall be treated as sewage and handled properly during the cleaning and/or exchange process.

## 5. **Septic Tank Markings**

Tank information (size, date manufactured, name of manufacturer and indication of limit of external loads/cover depths required by Section 13 of ASTM C 1227) shall be located on the top of the tank between the outlet access hole and outlet wall or on the vertical outlet wall between the top of the tank and the top of the outlet opening.

## 6. **Performance Testing**

When necessary due to installation concerns, testing for leakage will be performed using either a vacuum test or water-pressure test.

Vacuum Test: Seal the empty tank and apply a vacuum to 4 in. (50 mm) of mercury. The tank is approved if 90% of vacuum is held for 2 minutes.

Water-Pressure Test: Seal the tank, fill with water, and let stand for 24 hours. Refill the tank. The tank is approved if the water level is held for 1 hour.

## 7. **Tank Abandonment**

Abandonment of septic tanks, or hollow leaching structures, shall be performed in such a manner as to eliminate the danger of the structure inadvertently collapsing. The responsibility for abandonment lies with the property owner. When hollow structures are abandoned the chamber shall be emptied of all septage wastes, and the structure shall be filled with clean sand and gravel, or the structure shall be crushed and the area backfilled with clean soil.

## **B. Septic tank capacities**

1. The minimum liquid capacity of septic tanks serving residential buildings shall be based on the number of bedrooms in the building. For three bedrooms or less, a 1000-gallon tank is required; and another 250-gallons shall be added for each additional bedroom above three.
2. The minimum liquid capacity of septic tanks serving non-residential buildings and residential institutions shall be equal to the 24-hour design flow (see Table No. 4). In no case shall a septic tank be installed with a liquid capacity of less than one thousand gallons. In cases of non-residential buildings that are subject to high peak sewage flows, the liquid capacity of the septic tank shall provide a minimum detention time of 2 hours under peak flow conditions. The required septic tank capacity shall be increased by a minimum of 50% at food service establishments and restaurants in instances of repairs of existing subsurface sewage disposal systems where it is determined that it is not feasible to install a grease interceptor tank or internal grease recovery unit.
3. Whenever more than 25 percent of the daily design flow from a building served will be pumped into the septic tank, the size of the tank shall be increased 50 percent beyond the minimum capacity required per Standard V B.
4. The liquid capacity of a septic tank shall be increased whenever a residential building contains a garbage grinder or large capacity bathtub in accordance with the following:

Garbage grinder:

Add 250 gallons to required capacity of the septic tank.

Large tub

100 to 200 gallon tub: Add 250 gallons to required capacity of the septic tank

Over 200 gallon tub: Add 500 gallons to required capacity of the septic tank.

### C. Grease interceptor tanks

Grease interceptor tanks shall be provided for restaurants and food service establishments with design flows of 500 gallons per day or greater for new construction and repairs of existing subsurface sewage disposal systems where feasible. If it is determined that it is not feasible to install a grease interceptor tank on a food service/restaurant system repair, a mechanical grease recovery unit (GRU) is recommended to be retrofitted on the internal wastewater piping in the kitchen. If a grease interceptor tank or an internal GRU is not included in a food service/restaurant septic system repair, then the required septic tank capacity shall be increased by a minimum of 50% (see Standard V B).

Grease interceptor tanks shall receive wastewater from the kitchen waste lines only. Effluent discharged from the grease interceptor tank shall be directed to the inlet end of the septic tank. The capacity of grease interceptor tanks shall be a minimum of 1000 gallons and shall meet or surpass the 24-hour design flow. For restaurants and food service establishments with design flows of 2,000 gallons per day or greater, two grease interceptor tanks in series shall be provided. Such grease interceptor tanks shall have a combined liquid volume meeting or surpassing the 24-hour design flow. Grease interceptor tanks shall have inlet and outlet baffles that extend to a depth of six to twelve inches above the tank bottom (see Figure No. 6) and extend at least five inches above the liquid level. All manholes and cleanouts on grease interceptor tanks shall be extended to grade to facilitate cleaning. Grease interceptor tanks shall be provided with manhole covers that have been placarded with notification as to the danger of entering the tank due to noxious gases.

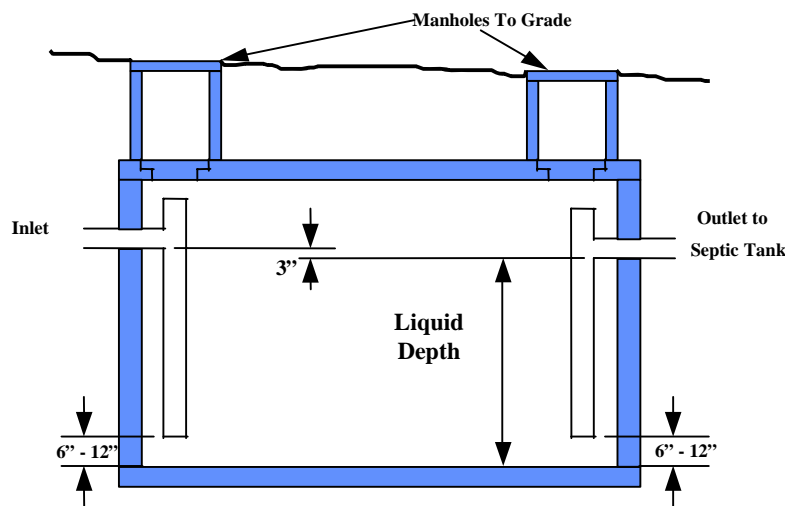

**FIGURE NO. 6 - GREASE INTERCEPTOR TANK**

Grease interceptor tanks can be single or two compartment tanks and shall be constructed out of concrete or other durable material approved by the Commissioner of Public Health. Concrete grease interceptor tanks shall meet all structural and access requirements for concrete septic tanks. This includes applicable configuration (pipe seals, inlet/outlet differential, etc) and access (riser sizes, stepped covers, etc) requirements consistent with the requirements for concrete septic tanks. Concrete grease interceptor tanks shall be marked with tank information (size, name of manufacturer, date manufactured, loading limits), and be subject to other applicable septic tank provisions (performance testing, cleaning, tank abandonment, etc). Non-concrete grease interceptor tanks shall also meet all of the requirements for concrete grease interceptor tanks excluding the structural and marking requirements. Non-concrete grease interceptor tanks must be approved by the Commissioner of Public Health. Non-concrete grease interceptor tanks shall be marked with the manufacturer's name and tank designation number.

**VI. DISTRIBUTION OF SEPTIC TANK EFFLUENT**

**A. General**

Septic tank effluent shall be distributed by gravity, pump, or siphon in a manner that promotes uniform distribution of effluent and full utilization of the leaching system. Leaching systems shall be designed to avoid effluent backflow into the septic tank. Leaching systems shall be provided with access points consisting of distribution boxes, cleanouts (galleries, pits), or capped sanitary tees extended to grade. At least one access point shall be provided for each leaching system row. A single distribution box feeding rows at the same elevation on either side of the distribution box shall constitute access points for both rows. Leaching systems with rows at the same elevation (level systems) shall have ends connected wherever feasible (see Figure No. 7). Non-level leaching systems may apply effluent by dosing (pump, siphon), serial distribution with high-level overflow (see Figures No. 8, 9 and 10), or by approved effluent splitting devices (i.e., Polylok Dipper D-Box or Equalizer pipe inserts, Zoeller Tru Flow D-box).

**B. Mandatory Dosing**

Large subsurface sewage disposal systems (2000 gallons per day or greater) with more than 600 linear feet of leaching system shall utilize intermittent dosing arrangements. Dosing can be accomplished by pump, siphon, or other approved methods such as the Rissy Plastics' Floating Outlet Distribution Chamber (FLOUT). Dosing systems shall be designed to discharge at least fifty percent of the volume of the distributing pipes and/or to dose the leaching system at a frequency of three to six cycles per day. Dosing chambers shall have access manholes to grade. Pump systems shall be designed with duplicate alternating pumps. Alternating pump and siphon systems shall be designed to provide full leaching system utilization in the event one pump or siphon fails to operate.

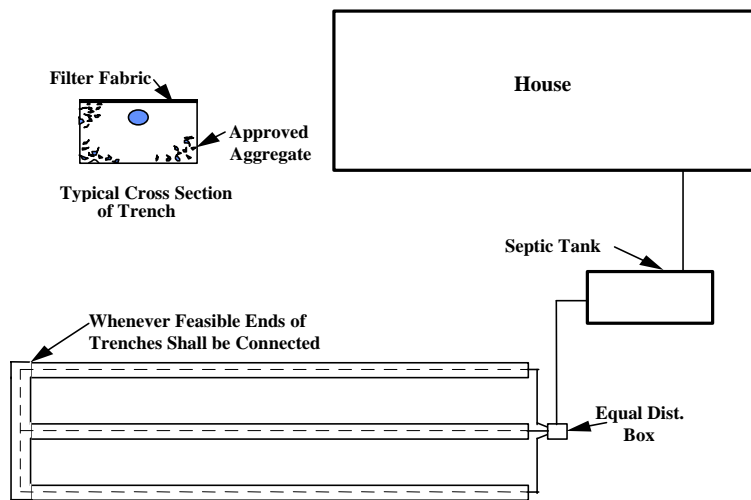

**FIGURE NO. 7 - LEVEL LEACHING SYSTEMS**

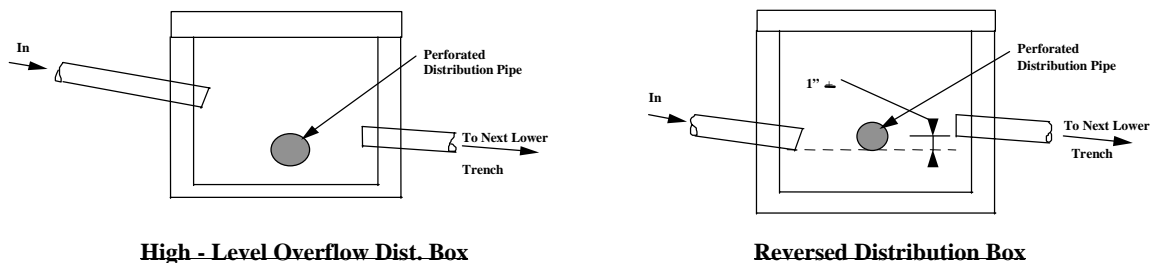

**FIGURE NO. 8 - SERIAL DISTRIBUTION BOXES**

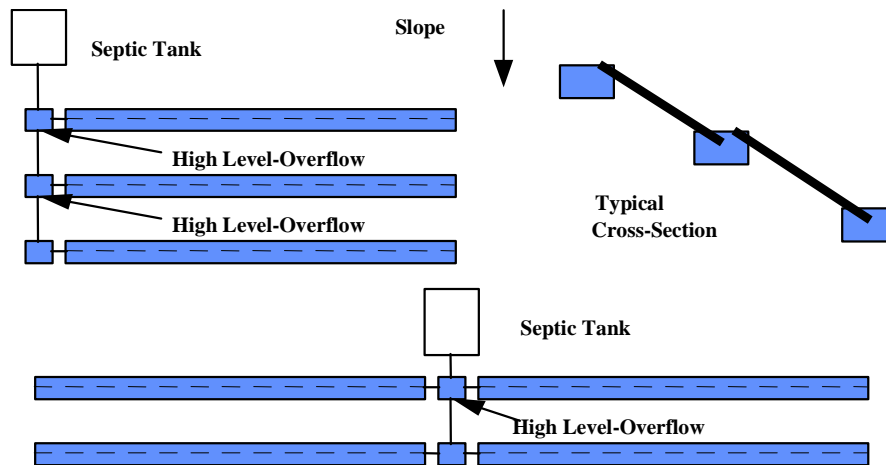

**FIGURE NO. 9 - SERIAL DISTRIBUTION SYSTEM**

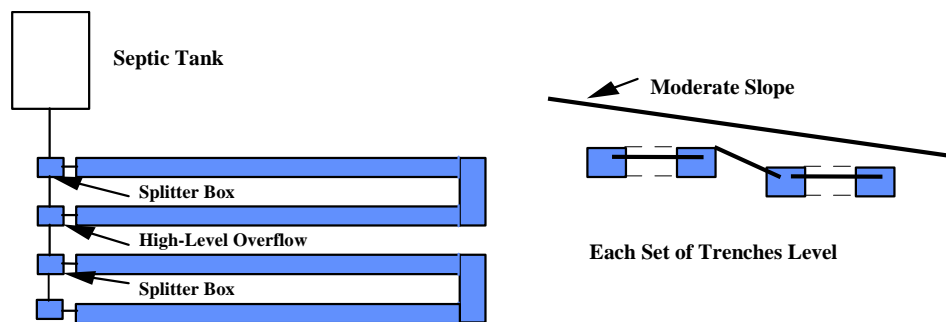

**FIGURE NO. 10 - ALTERNATIVE DISTRIBUTION SYSTEMS**

### C. Pump Systems

Effluent pump chambers shall be provided with risers to grade and a high-level alarm. Effluent pumps must be approved by the manufacturer for use in sewage systems. Freeze protection must be provided for all force mains. This can be accomplished by deep burial (below frost line) or back drainage into the pump chamber thru a weep hole in the force main. Back siphonage from the leaching system and/or excessive pump cycling must be avoided when a weep hole is provided. Pump chambers in high groundwater areas shall be tested for leakage to insure water tightness. For pump systems other than those covered by Standard VI B, duplicate alternating pumps or a single pump with emergency storage volume (above the alarm float level) in the pump chamber equal to at least the daily design volume shall be provided. All electrical work on the pump system requires a separate permit from the local building official.

Specifications shall be provided for all the internal components of the pump chamber. This includes the pump(s), piping, floats, alarms, disconnect chain, valves, etc. On/off and alarm float levels must be specified along with the approximate dose volume and emergency storage provided. The pump must be rated to handle the design flow rate at the total dynamic head for the installation. A check valve must be provided on the pump discharge line unless the pump manufacturer does not require one. Piping unions, lift chain and manhole location must allow for convenient pump removal for routine maintenance. Internal pump chamber appurtenances must be non-corrosive and suitable for the corrosive effluent environment.

Pump chambers must be made out of concrete or other durable material approved by the Commissioner of Public Health. Non-concrete pump chambers must be installed in accordance with the manufacturer's instructions. See Standard V A 1 b for further restrictions/requirements for the installation of non-concrete tanks. Concrete pump chambers shall meet all structural requirements for concrete septic tanks.

Concrete pump chambers shall be marked with tank marking information (size, name of manufacturer, date manufactured, loading limits) and be subject to other applicable septic tank provisions (performance testing, tank abandonment, etc.).

Combination septic tank/effluent pump systems may be utilized in instances where space constraints or other site limitations make it advantageous to install a single tank/pump unit. Combined septic tank/effluent pump systems must utilize an approved screened pump vault installed in the second compartment of an oversized two-compartment septic tank. Emergency storage must be provided for single pump systems. Draw down only in the second compartment is recommended. Use of mid-liquid depth tee baffles with a compartment connection pipe at the liquid level can be used to draw down effluent in second compartment only. Required septic tank capacity must be provided below the “pump-off” level.

Raw sewage pumps are not recommended for use with subsurface sewage disposal systems. Where pumping is required, and the installation of a separate pump chamber is not possible, combination septic tank/effluent pump systems should be utilized. In the event raw sewage pumps are necessary, solids handling (ejector) pumps are recommended over grinder pumps. If raw sewage pumps are necessary for basement fixtures, upper level flows should be directed to the septic tank by gravity where feasible. In the event more than 25% of the daily design flow will be pumped into the septic tank, the required septic tank capacity shall be increased per Standard V B 3. Raw sewage pumps outside the building served are considered part of the subsurface sewage disposal system; therefore, they must be installed in compliance with the separation distance requirements in Table No. 1. Exterior raw sewage pump systems shall be provided with an access to grade and a system malfunction alarm.

#### **D. Leaching System Enhancement/Rejuvenation**

The patented Soil Air System marketed by Wastewater Environmental Technologies (in conjunction with Geomatrix, LLC) may be utilized on new leaching systems, or on existing systems that are not at risk of hydraulically overloading the naturally occurring soil and provide the required minimum separation distance above ledge rock and maximum groundwater. The Soil Air System may allow some restoration of infiltrative capacity of the leaching system/soil interface in instances where the long-term effluent acceptance rate has diminished over time. Utilization of the Soil Air System requires a permit from the local director of health. Site investigations will be necessary to gather soil test information if the data is not readily available.

Existing sewage disposal systems that are determined to be candidates for the Soil Air System must be evaluated to determine the extent of current code compliance. A repair plan must be prepared identifying the location of the existing system and, if feasible, a code-complying area. Sites that cannot support a code-complying area shall have a potential repair area identified. Large system sites (2,000-5,000 GPD) must have engineered plans prepared and approved from the Commissioner of Public Health as required by PHC Section 19-13-B103d (c). The local director of health can require engineered plans in areas of special concern on sites less than 2000 gallons per day per code provisions.

The Soil Air System shall not be utilized on cesspools, or on excessively undersized leaching systems, unless it is determined that it is not feasible to expand the leaching system. Leaching systems are considered to be excessively undersized if they provide less than 50 percent of the required effective leaching area. The local director of health may require further upgrades to existing sewage disposal systems in conjunction with implementation of the Soil Air System. Upgrades may include leaching system expansion or the installation of additional tanks (septic, grease interceptor).

Soil Air Systems must be periodically evaluated/monitored to verify satisfactory system operation. The local director of health shall stipulate monitoring and reporting requirements on the permit to discharge. The discharge permit must also stipulate that the local director of health be notified in writing in the event the Soil Air System is no longer in use on a site.

#### **E. Leaching System Clogging Break-up**

The patented Terra-lift process may be utilized on existing sewage disposal systems that provide the required minimum separation distance above ledge rock and maximum groundwater, and that have historically operated satisfactorily but have experienced declining capacity due to infiltrative surface clogging. Utilization of the Terra-lift process requires a permit from the local director of health. Site investigations will be necessary to gather soil test information if the data is not readily available.

Existing sewage disposal systems that are determined to be candidates for the Terra-lift process must be evaluated to determine the extent of current code compliance. A repair plan must be prepared identifying the location of the existing system and, if feasible, a code-complying area. Sites that cannot support a code-complying area shall have a potential repair area identified. Large system sites (2,000-5,000 GPD) must have engineered plans prepared and approved from the Commissioner of Public Health as required by PHC Section 19-13-B103d (c). The local director of health can require engineered plans in areas of special concern on sites less than 2000 gallons per day per code provisions.

The Terra-lift process shall not be utilized on cesspools, or on excessively undersized leaching systems, unless it is determined that it is not feasible to expand the leaching system. Leaching systems are considered to be excessively undersized if they provide less than 50 percent of the required effective leaching area. The local director of health may require further upgrade of existing sewage disposal systems in conjunction with implementation of the Terra-lift process. Upgrades may include leaching system expansion or the installation of additional tanks (septic, grease interceptor).

### **VII. PERCOLATION TESTS**

A percolation test consists of three steps: 1) presoaking the percolation hole, 2) refilling and allowing the hole to saturate under certain conditions, and 3) determining the minimum uniform percolation rate after saturation.

The purpose of the presoak is to allow sufficient soil-water contact time. During presoaking, swelling clays that may be present in the soil will expand thereby reducing the void space in the soil. Sufficient presoaking will also allow the advancing capillary wetting front, which controls the rate of water flow in unsaturated soils, to move sufficiently far away from the test hole so that an apparent equilibrium flow rate is reached.

The required presoaking time will vary depending on the soil and its moisture content. Presoaking shall be started by filling the percolation hole with 12 inches of water. If the water seeps away in less than 2 hours, the hole may be refilled to the 12-inch depth and the percolation test begun. If any water remains in the hole after 2 hours, it normally shall be refilled to the 12-inch depth and allowed to presoak for at least 2 additional hours before the percolation test is begun. However, such extended presoaking shall not be required where it is determined that the soil contains no significant amount of swelling clays. Any test hole that has continuously contained water for 4 hours or longer shall be considered adequately presoaked. Once clay particles have become swollen, they will remain so for a period of time. Therefore, it is not necessary to perform the percolation test immediately, although tests performed at the end of the presoaking period yield the most accurate results. If tests cannot be performed immediately, test holes may be presoaked in the morning and tested in the afternoon, or presoaked on one day and tested the following day. If more than 30 hours have elapsed following initial presoaking, the test hole shall be presoaked once again.

Following presoaking, the hole shall be refilled and allowed to percolate for 30 to 60 minutes, unless the hole goes dry, in order to fill the voids in the soil surrounding the test hole with water. Presoaking does not eliminate this requirement since the large voids surrounding the test hole will drain rapidly when the test hole goes dry. There is an initial rapid drop of the water level in the test hole as the water enters the voids in the soil. The rate of drop will diminish rapidly until after 30 to 60 minutes an apparent equilibrium rate will be attained. Only this minimum uniform rate following saturation shall be used in calculating the size of the leaching system. Readings taken prior to 30 to 60 minutes after refilling normally shall not be used in calculating the percolation rate. However, if after presoaking the refilled hole goes dry before 30 minutes, the readings that have been taken may be used without a second refilling.

Percolation tests shall be made in a 6 to 12 inch diameter hole dug to the depth of the proposed leaching system. At locations where there appears to be 2 or more soil strata of different texture or structure, each strata shall be tested separately with holes of comparable depths. In calculating the required leaching area (primary and reserve), only representative test results in the area and at the depth of the proposed leaching system shall be used, but all percolation tests and observation pits which were made on the site shall be reported. Whenever leaching systems are installed totally in fill material the size of the system shall be based on the percolation rate of the natural soils below or the fill material, whichever rate is slower. When the underlying natural soil has a percolation rate slower than 30 minutes per inch, the leaching system can be sized at a 30 minute/inch rate, as long as the fill material has a faster percolation rate.

**VIII. LEACHING SYSTEMS**

**A. General**

No leaching system shall be constructed in areas where high groundwater, surface flooding or ledge rock will interfere with its effective operation. Leaching systems should be installed as shallow as possible. The maximum depth of the bottom of a leaching system below finished grade shall be eight feet. The bottom of any leaching system shall be at least eighteen inches above the maximum groundwater level and at least four feet above ledge rock. Additional separation must be provided if the natural soil has a percolation rate faster than one minute per inch. In these instances the minimum separation to maximum groundwater must be increased to twenty-four inches, and the minimum separation above ledge rock shall be increased to eight feet or the distances shall be doubled from any well in accordance with Standard II, Table No. 1, Item A, Special Provisions.

The applicant shall submit calculations to demonstrate compliance with the Minimum Leaching System Spread (MLSS) criteria using the procedure outlined in Appendix A of the Technical Standards. No sewage disposal system shall be denied based solely upon non-compliance with MLSS but may be denied if the applicant is unable to demonstrate compliance with PHC Section 19-13-B103e (a)(4).

New subsurface sewage disposal systems constructed in areas where there is no definite schedule for the extension of public sewers within five years shall be laid out in such a manner to provide an acceptable reserve leaching area of suitable soil; or in the case of existing single-family residential building lots, potentially suitable soil for the purpose of enlargement or replacement of the primary leaching system. An area with potentially suitable soil contains less than four feet of existing soil above ledge rock but at least two feet of which is naturally occurring soil. No reserve area shall be required for repairs, alterations or extensions of existing leaching systems. No single-family residential building lot shall be required to fill a reserve area at the time of installation of the primary system; however, if fill is to be placed in the reserve area as part of the primary system construction, then the reserve area fill must be select fill to facilitate future use (see leaching system cross section below). Reserve areas for multi-family dwellings and commercial buildings without exceptions shall be prepared with necessary select fill and all designated reserve areas, whether residential or commercial, shall be identified on a plan to be filed at the local health department and Building Authority.

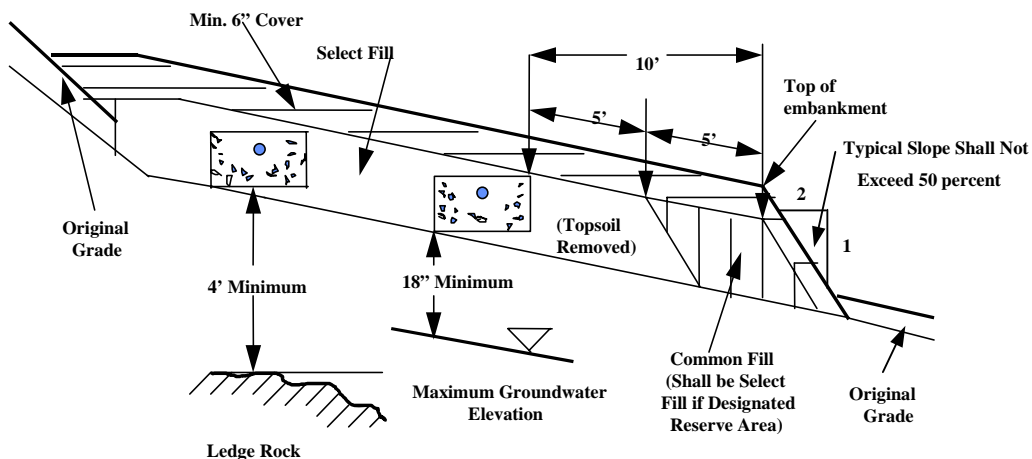

**MINIMUM SEPARATING DISTANCES ABOVE LEDGE ROCK AND GROUNDWATER**



The ground surface over the entire subsurface sewage disposal system shall be graded and maintained to lead surface water away from the area. All leaching systems shall be protected from siltation and erosion during and after construction. Leaching systems shall be covered with a minimum of six inches of soil and finished in a condition that will prevent erosion over and adjacent to the leaching system. Proprietary leaching systems shall be covered with additional soil in conformance with the manufacturer's installation specifications. The licensed installer shall properly cover the leaching system within two (2) working days following the local health department's final inspection and approval.

No cast iron or ductile iron piping shall be allowed following the septic tank or grease interceptor tank due to corrosive factors. Use of 3" diameter PVC, meeting ASTM D 2729 specifications or 4" diameter PVC, meeting ASTM D 3034, SDR 35 or equal, is required for all solid distribution piping (see Table No. 5).

The length of individual leaching trenches, gallery or proprietary leaching system rows shall not exceed 75 feet measured from the inlet, except that in installations where intermittent dosing exceeding 25 gallons/cycle is used, a maximum length of 100 feet may be utilized.

A layer of non-woven filter fabric shall be placed over all approved aggregate used in leaching system construction before backfilling. Minimum average roll values for fabric used for covering stone aggregate shall have a unit weight of 1.5 oz./yd<sup>2</sup> (per ASTM D 5261), a permittivity of 1.0 sec<sup>-1</sup> (per ASTM D 4491) and a trapezoid tear of 15 lbs. (per ASTM D 4533). All non-woven filter fabric used for proprietary leaching systems and for covering approved aggregate shall bear the appropriate manufacturer's label specifying the product's name and identification number. Labeling shall be affixed in such a manner to be readily visible to facilitate inspection. The Commissioner of Public Health shall maintain a list of approved filter fabrics. The approved list as of the date of this revision is provided in Appendix C.

Whenever different type leaching units are utilized side-by-side the average of the two required minimum center-to-center spacing shall be maintained. All leaching products with effective leaching credits of 7.4 SF/LF and higher shall not be utilized where the underlying naturally occurring soils have a percolation rate slower than 30 minutes per inch.

Select fill placed within and adjacent to leaching system areas shall be comprised of clean sand, or sand and gravel, free from organic matter and foreign substances. The select fill shall meet the following requirements unless otherwise approved by a professional engineer for use within the leaching area:

1. The select fill shall not contain any material larger than the three (3) inch sieve.
2. Up to 45% of the dry weight of the representative sample may be retained on the #4 sieve (This is the gravel portion of the sample).
3. The material that passes the #4 sieve is then reweighed and the sieve analysis started.
4. The remaining sample shall meet the following gradation criteria:

SIEVE SIZE	PERCENT PASSING	
	WET SIEVE	DRY SIEVE
#4	100	100
#10	70 - 100	70 - 100
#40	10 - 50 *	10 - 75
#100	0 - 20	0 - 5
#200	0 - 5	0 - 2.5

\* Percent passing the #40 sieve can be increased to no greater than 75% if the percent passing the #100 sieve does not exceed 10% and the #200 sieve does not exceed 5%.

The licensed installer is responsible for preparing the leaching area with necessary select fill. The topsoil in the leaching system area must be removed and the subsoil scarified prior to select fill placement unless otherwise directed by the design engineer. The installer shall take the necessary steps to protect the underlying naturally occurring soil from over compaction or damage. Select fill shall extend a minimum of five (5) feet laterally in all directions beyond the outer perimeter of the leaching system.

The Commissioner of Public Health must approve manufactured fill. Rock used to produce manufactured fill must have a loss of abrasion of not more than 50 % using AASHTO Method T-96. Suppliers of manufactured fill must make application for approval to the Commissioner of Public Health. Documentation must be submitted on the quarry operation, and production process. Fill specifications (gradation, permeability, etc) and a narrative of the quality control/quality assurance program must also be included. The manufactured fill producers must provide annual product registrations to the Commissioner of Public Health.

**B. Leaching trenches (See Figure No. 11)**

All leaching trenches shall follow ground contours. Trench widths shall be 18, 24, 30, 36, or 48 inches. No trench shall exceed 48 inches in width. The trenches shall contain a depth of at least twelve inches of approved aggregate. A distribution pipe shall be laid the entire length of the trench near the top layer of aggregate. Distribution pipes shall be of acceptable material (see Table 5) with suitable perforations or open joints laid in a downward direction. Distribution pipes shall be laid level or on a grade not exceeding two to four inches per one hundred feet. The distribution pipes shall be covered with at least two inches of approved aggregate, and there shall be at least six inches (for 48” wide trenches) or twelve inches (for 36” or less wide trenches) of this material under the distribution pipe.

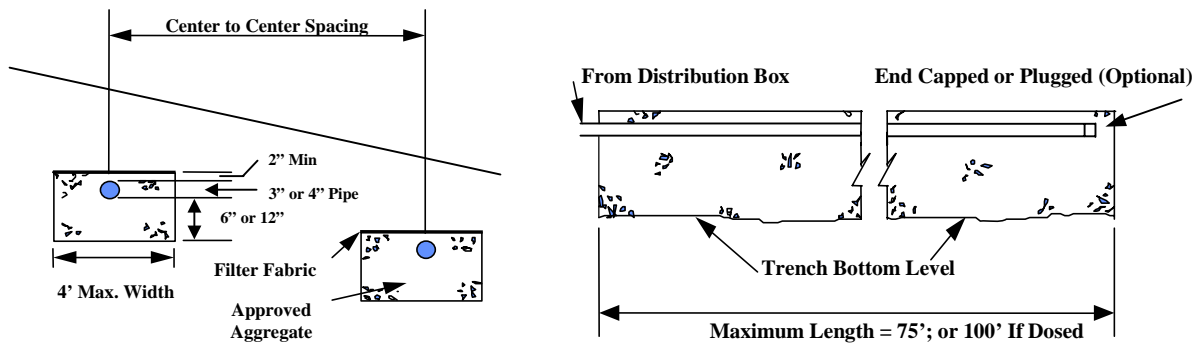

**FIGURE NO. 11 - LEACHING TRENCHES**

For the purposes of Standard VIII F the effective leaching area of leaching trenches and corresponding minimum center-to-center spacing between trenches shall be as follows:

Trench Depth (inches)	Trench Width (inches)	Effective Leaching Credit (SF/LF)	Center to Center Spacing (feet)
18	18	2.1	9
18	24	2.4	9
18	30	2.7	9
18	36	3.0	9
12	48	3.0	9

**TABLE NO. 5 - DISTRIBUTION PIPE**

USE	PIPE DESCRIPTION	TYPE OF JOINT	REMARKS
Solid and perforated effluent distribution pipe used after the septic tank for leaching system  (Also see Table 2D for sewage force main)	PVC ASTM D 3034, SDR 35 PVC ASTM F 789, PS-46 PVC ASTM F 891, PS-50 PVC ASTM F1760 SDR35	Rubber compression gasket, or bell and spigot with no gasket	Heavy duty plastic pipe for shallow pipe installation
	PVC ASTM D 2729 - only 3" diameter pipe (see remarks for use of 4" pipe)	Bell and spigot, no gaskets	4" diameter pipes can be used but must be bedded in 6" min. of approved aggregate and covered with 2" min. of aggregate or with other special bedding requirements to protect against crushing  4" diameter corrugated smooth interior wall polyethylene leaching pipe meeting ASTM D 3350 and performance specification ASTM F 405 may be used without bedding
	PE ASTM F 810, SDR 38 PE ASTM D 3350 - only 3" diameter pipe (see remarks for use of 4" pipe)	Bell and spigot, no gaskets	
	PE corrugated rigid pipe: ASTM 1248 (coil pipe not acceptable) - only 3" diameter pipe (see remarks for use of 4" pipe)	Sleeve joints	
	PE ADS N-12, ASTM F 667, AASHTO M-294	Snap on sleeve joint	Gasket couplings for watertight installation are available

**C. Leaching pits (See Figure No. 12)**

Leaching pits shall be hollow structures with perforated or open-joint walls and tight covers. The side walls shall be surrounded by at least twelve inches, but not more than twenty-four inches, of approved aggregate and the hollow structure shall be no less than five feet in diameter nor greater than ten feet in diameter. Pit covers shall be equipped with a cleanout manhole. Center-to-center spacing of leaching pits shall be at least four times the diameter of the hollow structure. No more than two leaching pits shall be connected in series. Leaching pits shall not be used where groundwater may interfere with their operation or where soil of better leaching quality is found at shallow depth. The bottom of leaching pits shall not be more than eight feet below finished grade. Leaching pits shall not be used where the percolation rate is slower than twenty minutes per inch.

For the purposes of Standard VIII F, the effective leaching area of leaching pits shall consist of only the side area of the usable aggregate-filled excavation. The maximum utilization of a leaching pit cannot be higher than the septic tank outlet elevation or the high-level overflow elevation of the serial distribution box.

$$\text{Effective Area} = \text{Excavation Diameter} \times \pi \times \text{Pit Depth}$$

(Note:  $\pi$  equals approximately 3.14)

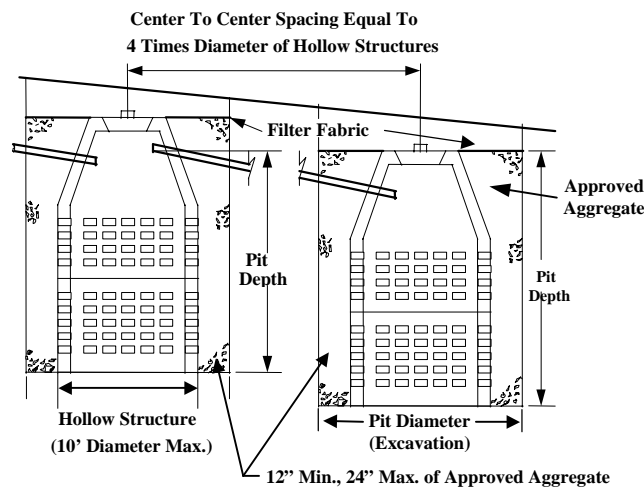

**FIGURE NO. 12 - LEACHING PITS**

**D. Leaching galleries (See Figures No. 13)**

Leaching gallery rows shall follow ground contours. Leaching galleries shall be hollow structures with perforated or open joint sides and tight covers. Leaching galleries must provide a minimum 40 inches of open bottom width. The sidewalls shall have a minimum depth of twelve inches and a maximum depth of four feet, including up to six inches of approved aggregate above the top of the structure. Twelve inches of approved aggregate shall be placed on the sides of the galleries and on the ends of the gallery rows. The width of the trench excavation shall not be less than six feet and the width of the hollow structure(s) shall be not less than four feet. The bottom of each leaching gallery row shall be level.

For the purposes of Standard VIII F the effective leaching area of gallery rows and corresponding minimum center-to-center spacing between rows shall be as follows:

Gallery Height (inches)	Effective Leaching Credit (SF/LF)	Center to Center Spacing (feet)
48	9.2	18
36	8.0	18
30	7.4	15
27	7.1	15
24	6.8	15
18	6.2	15
12	5.9	15

Multiple plastic units (twin, in the case of Infiltrator Sidewinders or PSA BioDiffusers; or four unit configuration, as in the case of Contactor Field Drain C-4), or single large plastic chambers (Infiltrator ISI 3050 or Cultec Recharger 330), are approved in a gallery configuration (See Figure 13). Gallery height shall be determined from bottom of excavation to maximum level of utilization (determined by outlet invert of septic tank or high-level overflow elevation of a serial distribution box). Total length of excavated row shall be utilized to calculate effective area. L-shaped, U-shaped, or box gallery row extensions shall not be credited unless the restrictive layer as defined by MLSS is greater than 60 inches, or the underlying groundwater gradient is less than 1%. A 0.3 SF/LF reduction will be assessed to all gallery rows when the gallery units are placed on a bed of approved aggregate.

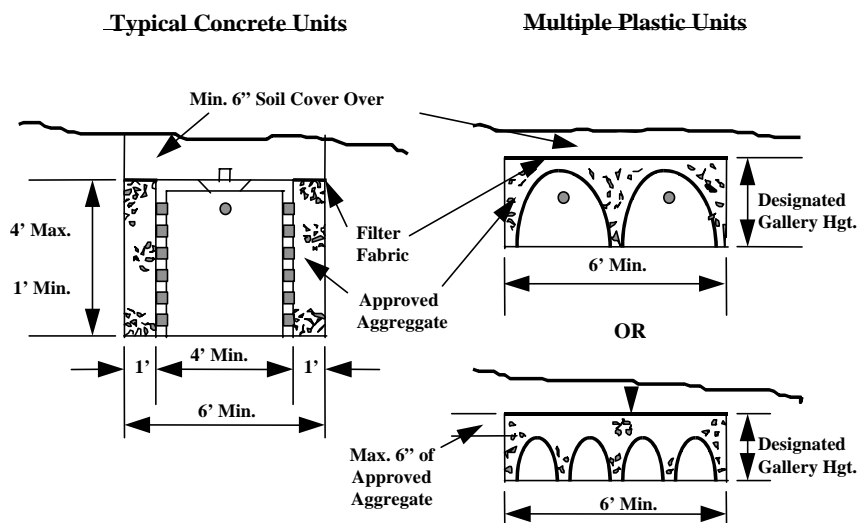
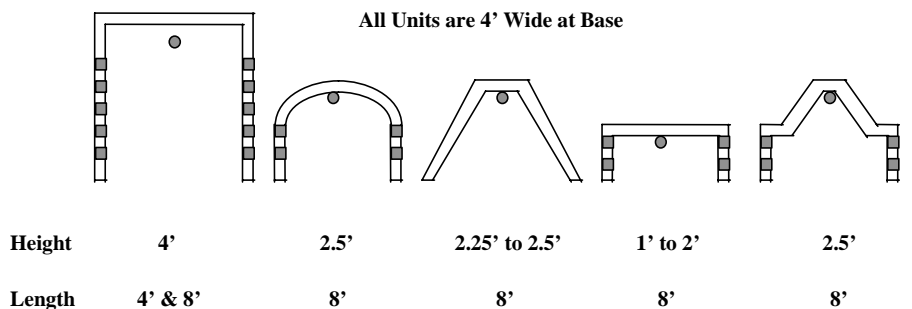

**FIGURE NO. 13 - TYPICAL LEACHING GALLERY STRUCTURES**

### E. Proprietary Leaching Systems

Proprietary leaching system rows shall be installed level and follow ground contours. The units must be backfilled with select fill unless otherwise noted. Installation procedures, including the minimum depth of cover, shall be per manufacturer's specifications.

#### 1. Plastic Leaching Chambers

For the purpose of Standard VIII F the effective leaching area of the approved products listed below and corresponding minimum center-to-center spacing shall be as follows:

Product Name	Dimensions (W x H)	Effective Leaching Credit (SF/LF)	Center to Center Spacing (feet)
PSA - BioDiffuser (11)	34" x 11"	3.6	9
PSA - BioDiffuser (14)	34" x 13.5"	3.7	9
Hancor - EnviroChamber (Stand.)	34" x 12"	3.6	9
Hancor - EnviroChamber (High Cap.)	34" x 17.5"	3.9	9
Infiltrator - Equalizer 24	15" x 11"	2.3	9
Infiltrator - Equalizer 36	22" x 13.5"	2.7	9
Infiltrator - Sidewinder (Stand.)	34" x 12"	3.7	9
Infiltrator - Sidewinder (High Cap.)	34" x 16"	3.9	9

Units must be backfilled with select fill or approved aggregate. A 0.5 SF/LF reduction will be assessed if the trench is backfilled with soil not meeting select fill criteria.

#### 2. Eljen In-drain Leaching Units

Eljen In-drain units must be bedded on the bottom and sides with sand fill meeting the manufacturer's specifications. For the purpose of Standard VIII F the effective leaching area of the approved products listed below and corresponding minimum center-to-center spacing shall be as follows:

Product Name	Dimensions (W x H)	Effective Leaching Credit (SF/LF)	Center to Center Spacing (feet)
Eljen In-drain - Type "B" Unit	36" x 7"	4.7	12

#### 3. RUCK A Fins

Ruck A Fins units must be bedded on the bottom and sides with sand fill meeting the manufacturer's specifications. For the purpose of Standard VIII F the effective leaching area of the approved products listed below and corresponding minimum center-to-center spacing shall be as follows:

Product Name	Dimensions (W x H)	Effective Leaching Credit (SF/LF)	Center to Center Spacing (feet)
Ruck A Fins - R1032C	32" x 7"	7.0	15

#### 4. **FORM CELL Living Filter**

Living Filter units must be bedded on the bottom and sides with sand fill meeting the manufacturer's specifications. For the purpose of Standard VIII F the effective leaching area of the approved products listed below and corresponding minimum center-to-center spacing shall be as follows:

Product Name	Dimensions (W x H)	Effective Leaching Credit (SF/LF)	Center to Center Spacing (feet)
Living Filter- LF1210	29" x 12"	3.9	9
Living Filter- LF1810	29" x 18"	5.5	15
Living Filter- LF2410	29" x 24"	7.0	15
Living Filter- LF3010	29" x 30"	8.6	18
Living Filter- LF3610	29" x 36"	10.1	21
Living Filter- LF1224	60" x 12"	7.4	15
Living Filter- LF1826	64" x 18"	11.0	21
Living Filter- LF2426	64" x 24"	14.2	21
Living Filter- LF3026	64" x 30"	17.3	24
Living Filter- LF3626	64" x 36"	20.4	27

#### 5. **Corrugated Leaching Systems Lined/Covered with Filter Fabric**

Units must be backfilled with select fill. For the purpose of Standard VIII F the effective leaching area of the approved products listed below and corresponding minimum center-to-center spacing shall be as follows:

Product Name	Dimensions (Diameter / W x H)	Effective Leaching Credit (SF/LF)	Center to Center Spacing (feet)
GEO-FLOW	12" Diam	2.3	9
Presby Env. - ENVIRO-SEPTIC	12" Diam	2.3	9
Presby Env. - SIMPLE-SEPTIC	12" Diam	1.5	9
ADS - SB2	10" Diam	0.9	9
Cultec - Contactor EZ-24	16" x 12"	1.9	9
Cultec - Contactor EZ-24 (PDS)	16" x 12"	2.5	9
Cultec - Contactor 75	26.5" x 12.4"	2.6	9
Cultec - Contactor 100	36" x 12.5"	3.7	9
Cultec - Contactor 100 (PDS)	36" x 12.5"	4.3	12
Cultec - Contactor 125	26.5" x 18"	2.9	9
Cultec - Recharger 180	36" x 20.5"	4.4	12
Cultec - Recharger 180 (PDS)	36" x 20.5"	5.1	12
Cultec - Recharger 280	46" x 26.5 "	6.5	15
Cultec - Recharger 280 (PDS)	46" x 26.5 "	7.1	15
Cultec - Recharger 330	52" x 30"	5.6	15

**F. Leaching System Sizing**

1. Leaching system sizing for residential buildings is based on a design flow of 150 gallons per day per bedroom (see Standard IV). Leaching systems for residential buildings shall be designed on the basis of the number of bedrooms and percolation rate in accordance with Table 6:

**TABLE 6 - RESIDENTIAL BUILDING**

<b>PERCOLATION RATE</b>	<b>SQUARE FEET OF REQUIRED EFFECTIVE LEACHING AREA</b>				
<b>MINUTES TO DROP ONE INCH</b>	<b>2 BEDROOM BUILDING</b>	<b>3 BEDROOM BUILDING</b>	<b>4 BEDROOM BUILDING</b>	<b>FOR EACH BEDROOM ABOVE FOUR</b>	
				<b>Single Family</b>	<b>Multi-family</b>
LESS THAN 10.1	375	495	660	100	165
10.1-20.0	500	675	900	150	225
20.1-30.0	565	750	1000	175	250
30.1-45.0	675	900	1200	225	300
45.1-60.0	745	990	1320	250	330
LESS THAN 5.0*	300	375	500	100	125
GREATER THAN 60.0	UNSUITABLE FOR LEACHING SYSTEMS				
* Lots in existence prior to January 1, 1994 may use the less than 5.0 minute/inch percolation rates if site conditions prohibit installations sized per above less than 10.1 minutes per inch rates.					



2. Leaching system for restaurants, bakeries, laundromats, hairdressing salons and residential institutions shall be designed based on the design flow (see Standard IV) and the application rates listed in Table 7:

**TABLE 7 - RESTAURANTS, LAUNDROMATS AND RESIDENTIAL INSTITUTIONS**

<b>PERCOLATION RATE</b> <b>(Minutes to Drop One Inch)</b>	<b>APPLICATION RATE</b> <b>(Gallons per day to one square foot of Effective Leaching Area)</b>
LESS THAN 10.1	0.8
10.1 to 20.0	0.7
20.1 to 30.0	0.6
30.1 to 45.0	0.5
45.1 to 60.0	0.4

$$\text{REQUIRED EFFECTIVE LEACHING AREA} = \frac{\text{DESIGN FLOW}}{\text{APPLICATION RATE}}$$

3. Leaching systems for non-residential buildings other than those covered by Standard VIII F 2 shall be designed based on the design flow (see Standard IV) and the application rates listed in Table 8:

**TABLE 8 - NON-RESIDENTIAL BUILDINGS**

<b>PERCOLATION RATE</b> <b>(Minutes to Drop One Inch)</b>	<b>APPLICATION RATE</b> <b>(Gallons per day to one square foot of Effective Leaching Area)</b>
LESS THAN 10.1	1.5
10.1 to 20.0	1.2
20.1 to 30.0	0.9
30.1 to 45.0	0.7
45.1 to 60.0	0.6

$$\text{REQUIRED EFFECTIVE LEACHING AREA} = \frac{\text{DESIGN FLOW}}{\text{APPLICATION RATE}}$$

**IX. GROUNDWATER, ROOF, CELLAR AND YARD DRAINAGE**

No groundwater drainage or drainage from roofs, cellars, roads or yards shall discharge into or within twenty-five feet of any portion of a subsurface sewage disposal system. Separate facilities shall be provided for such drainage. Storm water swales shall be constructed to lead water away from the subsurface sewage disposal system. The separating distance between drains and subsurface sewage disposal systems shall be as designated in Table No. 1. Groundwater control drains or curtain drains, if used, shall be located on the uphill side of leaching systems and on the sides if necessary, and shall be separated from these systems as specified in Table No. 1. The depth of these drains shall be such as to lower the ground water at least two feet below the bottom of the entire leaching system. Each drain shall be equipped with a collection pipe located 6 to 12 inches above the bottom of the trench carrying collected groundwater around and discharging below the leaching system (see Figure No. 14). This collection pipe shall have a minimum diameter of four inches and shall consist of open-joint tile, porous or perforated pipe. Perforated collection pipes are typically installed with holes on the bottom of the pipe. The collection pipe shall be surrounded by clean stone or gravel to a depth necessary to control groundwater or be otherwise designed by a professional engineer.

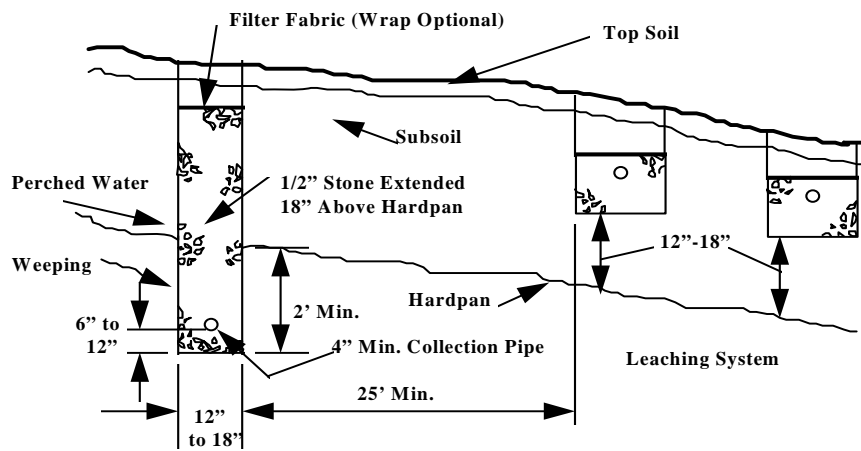

**FIGURE NO. 14 - TYPICAL CURTAIN DRAIN CONSTRUCTION**

**X. OTHER WASTEWATER**

Oils, greases, industrial/commercial wastes, toxic chemicals and wastewater that is not sewage, as defined in Public Health Code Section 19-13-B103b (a), shall not be discharged to a subsurface sewage disposal system. Discharges of wastewaters from water treatment systems (e.g., water softeners, iron or manganese removal) to surface waters, sanitary sewer systems, subsurface sewage disposal systems or to the ground are prohibited unless otherwise authorized by the Department of Environmental Protection. A separate, dedicated disposal system shall be provided for any water treatment system wastewaters that discharge to the ground.

**XI. NON-DISCHARGING SEWAGE DISPOSAL SYSTEMS**

**A. Large Capacity Composting Toilets**

Large capacity composting toilets shall have separate receiving, composting and storage compartments, arranged so that the contents are moved from one compartment to another without spillage, or escape of odors within the dwelling. No large capacity composting toilets shall have an interior volume of less than sixty-four cubic feet. All toilet waste shall be deposited in the receiving chamber, which shall be furnished with a tight self-closing toilet lid. Food waste or other materials necessary to the composting action shall be deposited in the composting compartment through a separate opening with a tight fitting

lid. The final composting material shall be removed from the storage compartment through a cleanout opening fitted with a tight door or lid. The cleanout shall not be located in a food storage or preparation area. The receiving and composting compartments shall be connected to the outside atmosphere by a screened vent. The vent shall be a minimum of six inches in diameter and shall extend at least twenty feet above the openings in the receiving and composting compartments, unless mechanical ventilation is provided. Air inlets shall be connected to the storage compartment only, and shall be screened.

**B. Heat Assisted Composting Toilets**

Heat assigned composting toilets shall have a single compartment furnished with a tight, self-closing toilet lid. The compartment shall be connected to the outside atmosphere by a screened vent. There shall be a mechanical ventilation fan arranged to control the humidity in the compartment and provide positive venting of odors to the outside atmosphere at all times. A heating unit shall be provided to maintain temperature in the optimum range for composting.

**C. Incineration Toilets**

Gas or oil fired or electrical incineration toilets shall meet applicable fire and building codes. No ignition or incineration shall occur unless the toilet lid is closed, and the blower shall operate continuously during incineration. A combustion temperature of 1,400°F or higher shall be maintained during incineration.

**D. Chemical Flush Toilets**

Chemical flush toilets shall have toilet bowls that may be flushed when required by chemicals or chemical solutions. The liquid shall be discharged to a holding tank for removal of solids by settlement or other means prior to re-circulation. The toilet bowl shall be trapped or otherwise constructed to exclude odors, and the holding tank shall be vented to the outside atmosphere. The holding tank shall be emptied or additional chemicals added when odors or other objectionable conditions occur.

**E. Dry Vault Privies**

Dry vault privies shall be constructed with adequate storage space for excreta, and a fly-tight vault with a screened vent to the outside atmosphere. Self-closing, fly tight doors or self-closing seat covers shall be provided. Dry vault privies shall be constructed so as to permit ready cleaning. Separating distances shall comply with Table No. 1.

**F. Chemical Privies**

Chemical privies shall be constructed with a watertight vault with a screened vent to the outside atmosphere. Separating distances shall comply with Table No. 1. Chemicals shall be added to the liquid in the pit through a covered opening outside the toilet building. The vault shall be emptied, or additional chemicals added, when odors or other objectionable conditions occur.

**G. Holding Tanks**

Installation of non-discharging effluent holding tanks must be approved by the Commissioner of Public Health and the septage disposed by methods in accordance with Section 19-13-B103c (a) of the Public Health Code.

FORM #1 State of Connecticut Department of Public Health Application/Permit No. \_\_\_\_\_

**APPLICATION FOR PERMIT TO CONSTRUCT OR REPAIR A SEWAGE DISPOSAL SYSTEM**

To the Director of Health Town of: \_\_\_\_\_ Date: \_\_\_\_\_

Application is hereby made for permit to construct a sewage disposal system for a: \_\_\_\_\_  
(Residence, Store, Restaurant, etc.)

Located at: \_\_\_\_\_  
(Street Address, Lot Number, Subdivision Name, Map, Block, Lot, etc.)

New System \_\_\_\_\_ Addition \_\_\_\_\_ Repair \_\_\_\_\_ Other \_\_\_\_\_

Owner \_\_\_\_\_ Address \_\_\_\_\_ Tel.No. \_\_\_\_\_

Installer \_\_\_\_\_ Address \_\_\_\_\_ Tel.No. \_\_\_\_\_

Installer License No. \_\_\_\_\_

In accordance with detailed information stated below

Application fee paid \_\_\_\_\_ Signed \_\_\_\_\_  
(Owner or duly authorized representative)

**GENERAL INFORMATION**

Subdivision Approval \_\_\_\_\_ Date \_\_\_\_\_ Lot size \_\_\_\_\_ sq.ft.

On Public Water Supply Watershed \_\_\_\_\_ On Designated Wetland \_\_\_\_\_

SCS Soil Classification \_\_\_\_\_ Public Sewer Scheduled \_\_\_\_\_  
(Date)

If residential, number of bedrooms \_\_\_\_\_ Flood Zone \_\_\_\_\_

If non-residential, design criteria: \_\_\_\_\_  
(Sanitary Facilities, No. of Employees, Meals Served, etc.)

Basement Fixtures \_\_\_\_\_ Foundation Drains \_\_\_\_\_ Special Equipment \_\_\_\_\_

ENGINEER'S PLAN REQUIRED	TEST DURING WET SEASON
--------------------------	------------------------

Water Supply \_\_\_\_\_ Type Well \_\_\_\_\_

Well Location Approved \_\_\_\_\_ Yield \_\_\_\_\_ Satisfactory Sample \_\_\_\_\_  
(Date)

Well Driller's Name \_\_\_\_\_ Address \_\_\_\_\_

WATER SUPPLY APPROVED
-----------------------

FORM #2 State of Connecticut Department of Public Health Application/Permit No. \_\_\_\_\_

**SITE INVESTIGATION FOR A SEWAGE DISPOSAL SYSTEM**

Property Owner \_\_\_\_\_ Location \_\_\_\_\_

**DEEP TEST PIT DATA/SOIL DESCRIPTIONS**

DATE: \_\_\_\_\_ (Record all Test Pits)

TEST PIT:	TEST PIT:	TEST PIT:	TEST PIT:
Mottles:	Mottles:	Mottles:	Mottles:
GW:	GW:	GW:	GW:
Ledge:	Ledge:	Ledge:	Ledge:
Roots:	Roots:	Roots:	Roots:
Restrictive:	Restrictive:	Restrictive:	Restrictive:

COMMENTS: \_\_\_\_\_  
 \_\_\_\_\_

GROUNDWATER TABLE (Near max., below max., etc.) \_\_\_\_\_

**PERCOLATION TEST DATA**

DATE: \_\_\_\_\_ (Record all Perc Tests)

PERC:		PERC:		PERC:		PERC:	
DEPTH:		DEPTH:		DEPTH:		DEPTH:	
PRESOAK:		PRESOAK:		PRESOAK:		PRESOAK:	
TIME	READING	TIME	READING	TIME	READING	TIME	READING
PERC RATE:		PERC RATE:		PERC RATE:		PERC RATE:	

COMMENTS: \_\_\_\_\_  
 \_\_\_\_\_

SOIL MOISTURE (High, medium, low, etc): \_\_\_\_\_

**SITE INVESTIGATION FOR A SEWAGE DISPOSAL SYSTEM**



**LOCATION DRAWING INCLUDING ALL TEST PITS AND PERCOLATION HOLES**

<b>SPECIAL CONDITIONS</b>		<b>CONCLUSIONS</b>	
Design Flow > 2000 GPD		Suitable for Sewage Disposal	
Public Water Supply Watershed		Unsuitable for Sewage Disposal	
Probable High Groundwater		Additional Investigation Req'd	
Slope > 25 percent		Wet Season Monitoring Req'd	
Perc Rate < 1 min/inch		Retest During Wet Season	
Perc Rate > 30 min/inch		Licensed Engineer Plan Req'd	
Ledge < 5 feet below grade		Other:	
Limited Suitable Area			
Open Watercourse or Wetlands			
Flood Plain / Seasonal Flooding			
G.W. < 36 inches below grade			

**DESIGN RECOMMENDATIONS/COMMENTS**

---



---



---

FORM COMPLETED BY: \_\_\_\_\_

OTHERS PRESENT FOR SITE INVESTIGATION (Sanitarian, Engineer, etc.)

---



---

FORM #3 State of Connecticut Department of Public Health Application/Permit No. \_\_\_\_\_

**CHECK LIST  
REVIEW OF PLAN/INSPECTION OF SEWAGE DISPOSAL SYSTEM**

Owner \_\_\_\_\_ Location \_\_\_\_\_ Date Rec'd \_\_\_\_\_

Plan prepared by \_\_\_\_\_ Title \_\_\_\_\_ Address \_\_\_\_\_

Site Investigation \_\_\_\_\_ Investigated by \_\_\_\_\_  
(Date)

Bench mark location \_\_\_\_\_ Elevation \_\_\_\_\_

Design Percolation Rate \_\_\_\_\_ Mins./inch at hole(s) \_\_\_\_\_

If residential, number of bedrooms \_\_\_\_\_ If non-residential, estimated daily flow \_\_\_\_\_

**HOUSE SEWER (INVERT LEVELS)**

Depth at foundation wall \_\_\_\_\_ Depth at septic tank \_\_\_\_\_

**SEPTIC TANK**

Cleanout located \_\_\_\_\_ ft. from \_\_\_\_\_ and \_\_\_\_\_ ft. from \_\_\_\_\_

Manufacturer \_\_\_\_\_ Size \_\_\_\_\_ gals. Depth to cleanout \_\_\_\_\_

**LEACHING SYSTEM**

Description \_\_\_\_\_

Effective area \_\_\_\_\_ sq.ft. Required effective area \_\_\_\_\_ sq.ft.

Spacing between units \_\_\_\_\_ ft. 100 % reserve area provided \_\_\_\_\_

Bottom of leaching system 18 inches above maximum water table \_\_\_\_\_

Bottom of leaching system 4 feet above ledge rock \_\_\_\_\_

Bottom of leaching system \_\_\_\_\_ inches below final grade.

Pumping required \_\_\_\_\_ Curtain drain required \_\_\_\_\_

Serial distribution \_\_\_\_\_ Level system \_\_\_\_\_

**SEPARATING DISTANCES**

Well Located \_\_\_\_\_ ft. from \_\_\_\_\_ and \_\_\_\_\_ ft. from \_\_\_\_\_

Distance sewage system to well on property \_\_\_\_\_ ft. To water service \_\_\_\_\_ ft.

To well on adjacent property \_\_\_\_\_ ft. To property line \_\_\_\_\_ ft.

To house served \_\_\_\_\_ ft To dwelling adjacent property \_\_\_\_\_ ft.

To nearest watercourse \_\_\_\_\_ ft. To nearest ground or surface water drain \_\_\_\_\_ ft.

Reviewed/inspected by \_\_\_\_\_ Title \_\_\_\_\_

PLAN/INSTALLATION APPROVED \_\_\_\_\_ DATE \_\_\_\_\_

INSPECTION FEE PAID \_\_\_\_\_

## APPENDIX A

### MINIMUM LEACHING SYSTEM SPREAD (MLSS)

No permit or approval shall be issued for any new subsurface sewage disposal system where the surrounding naturally occurring soil cannot adequately absorb or disperse the expected volume of sewage effluent. The MLSS calculation shall be utilized for all subsurface sewage disposal systems as a precursor to possible further, more in-depth, hydraulic analysis. The MLSS criteria should be applied to the primary leaching area. Wherever feasible the reserve leaching area should provide additional hydraulic relief.

#### MLSS Formula

$$\text{MLSS (in feet)} = \text{HF} \times \text{FF} \times \text{PF}$$

HYDRAULIC FACTOR (HF) = Factor based on hydraulic gradient and depth of restrictive layer within and down gradient of the leaching area.

FLOW FACTOR (FF) = Factor based on the design flow.

PERCOLATION FACTOR (PF) = Factor based on the percolation rate of the receiving naturally occurring soil.

#### DEFINITIONS

**Hydraulic Gradient:** Shall be deemed the percent of slope of the naturally occurring soil in the area of the leaching system (from uppermost leaching trench or gallery row to 25-50 feet down grade of system). Actual slope of restrictive layer may be utilized if field verification can be made.

**Restrictive Layer:** Shall be deemed the layer which impedes downward movement of flow within the proposed leaching area. This boundary will likely be the lesser of such conditions as: ledge; severely restrictive hardpan (slower than 30 minutes/inch) which is beneath a more permeable soil layer; or seasonal maximum groundwater levels. If clear determination of maximum groundwater levels cannot be made during site testing then this level shall be determined by groundwater monitoring. The average of at least four (4) consecutive weekly readings taken in the most restrictive 30-day period of the wet season shall be used as a basis.

**Depth to Restrictive Layer:** Shall be deemed the depth in inches from the top of naturally occurring grade to the restrictive layer. The average depth of natural soil above the restrictive layer in the area of the leaching system and between 25-50 feet down gradient shall be used to calculate MLSS.

**Leaching System Spread:** Shall be deemed the length in feet of sewage application parallel to the contours of the naturally occurring soils in the leaching area. Sewage shall be applied fairly uniformly over the entire length to be valid. If not, each section of the leaching system shall be analyzed independently in proportion to its daily discharge volume.



**FACTOR TABLES****HYDRAULIC FACTOR (HF)****HYDRAULIC GRADIENT ( % OF SLOPE )**

L  
T  
A  
O  
Y  
D  
E  
R  
R  
E  
E  
S  
I  
P  
T  
N  
R  
T  
I  
I  
C  
N  
H  
T  
C  
I  
H  
V  
E  
E  
S

	<1.0	1.0- 2.0	2.1- 3.0	3.1- 4.0	4.1- 6.0	6.1- 8.0	8.1- 10.0	10.1- 15.0	>15.0
<18.0	SEE NOTE #1								
18.0- 22.0	72	62	54	48	42	34	30	28	26
22.1- 26.0	66	56	48	42	34	30	28	26	24
26.1- 30.0	56	49	42	34	30	28	26	24	20
30.1- 36.0	48	42	34	30	28	26	24	20	18
36.1- 42.0	42	36	30	28	26	24	20	18	16
42.1- 48.0	36	32	28	26	24	20	18	16	14
48.1- 60.0	30	28	24	22	20	18	16	14	10
>60.0	MLSS NEED NOT BE CONSIDERED								

#1 - Cannot Be Approved Unless Hydraulic Analysis Demonstrates Suitability.

## FACTOR TABLES

### FLOW FACTOR (FF)

<b>Flow Factor = Design Flow / 300</b>	
<b>Typical Uses</b>	<b>Flow Factor (FF)</b>
<u>Residential:</u> Each Bedroom Has a Design Flow of 150 Gallons Per Day (GPD)	
2 Bedroom Home = 300/300	1.0
3 Bedroom Home = 450/300	1.5
4 Bedroom Home = 600/300	2.0, etc.
<u>Non-Residential:</u> Design Flow (GPD) / 300	( FF )

### PERCOLATION FACTOR (PF)

<b>Percolation Rate</b>	<b>Percolation Factor (PF)</b>
Up To 5.0 Minutes/Inch	1.0
5.1 To 10.0 Minutes/Inch	1.2
10.1 To 20.0 Minutes/Inch	1.5
20.1 To 30.0 Minutes/Inch	2.0
30.1 To 45.0 Minutes/Inch	3.0
45.1 To 60.0 Minutes/Inch	5.0

### USE OF MLSS FORMULA

The resulting MLSS calculation for each design plan shall be compared to the system spread proposed. If the proposed spread is less than the results of the MLSS formula than the applicant may either:

- 1) increase the system spread to meet MLSS;
- 2) relocate the leaching system to a more favorable location on the property;
- 3) reduce the flow factor by eliminating bedrooms or by changing the intended usage of the proposed building;
- 4) have an in-depth hydraulic analysis performed in order to demonstrate site suitability and code compliance.

**APPENDIX B****APPROVED SEPTIC TANK  
OUTLET FILTERS**

<b>MANUFACTURER</b>	<b>MODEL</b>
ORENCO SYSTEMS	FT0444-36, FT0854-36 FT1254-36, FT1554-36
PREMIER TECH	EFT-080
POLYLOK	PL-68, PL-122
RISSY PLASTICS	45 – CLIK N’ STICK
THORSBY & BOWNE	SANITEE
TUF-TITE	EF-4, EF-6
ZABEL	A100, A300 A1800, A1801 A100-HIP, A300-HIP A1800-HIP, A1801-HIP
ZOELLER	170-0017 170-0078 5000-0007
GAG SIM/TECH	GAG SIM/TECH FILTER
NORWECO	BIO-KINETIC BK2000

**APPENDIX C****APPROVED FILTER FABRICS**

<b>MANUFACTURER</b>	<b>DESIGNATION NUMBER</b>
AMERICAN ENGINEERING FABRICS	AEF-480
BRADLEY INDUSTRIAL TEXTILE	PHOENIX or LIJOMA
CARTHAGE MILLS	M35
CULTEC	410
DUPONT	SF20
ENGINEERED SYNTHETIC PRODUCTS	TNS R020
L&M SUPPLY COMPANY	L&M 231
MIRAFI	65304 (4’ WIDE) 65303 (3’ WIDE)
TERRA TEX	S01.5, P01.5
TYPAR	3151, 3201
US FABRIC INC	US 1.5 CT

**APPENDIX D****APPROVED NON-CONCRETE SEPTIC TANKS**

<b>MANUFACTURER</b>	<b>DESIGNATION/ID NUMBER</b>	<b>GALLONS</b>
NORWESCO Note: STD (Standard Tank) BSR. (Bruiser Tank)	STD. 1000 (Yellow Tank) STD. 1250 (Yellow Tank) STD. 1500 (Yellow Tank) BSR. 1000 (Blue Tank) BSR 1250 (Blue Tank) BSR 1500 (Blue Tank)	1000 1250 1500 1000 1250 1500
PLASTI-DRAIN (XACTICS)	X143600 X143605 X143850 X144700 X145500	1000 1000 1000 1250 1500
SNYDER PRODUCTS	50600187 50800187 51200187	1000 1250 1500
WEDCO PRODUCTS	WP3600 WP4000 WP5000 WP5700	1000 1050 1250 1500
ROCHESTER ROTATIONAL MOLDING	3445 3455 3465	1000 1250 1500
PREMIER TECH	PST-500 PST-660	1150 1500
DEN HARTOG INDUSTRIES (Ace Roto-Mold)	AST 1000-2	1000
FRALO PLASTECH	ST-1060 ST-1250 ST-1500	1060 1250 1500

# PUBLIC HEALTH CODE REGULATION

## On-Site Sewage Disposal Systems with Design Flows Greater than 5,000 Gallons per Day

### Sec. 19-13-B104a – Scope

These regulations set standards for domestic sewage disposal systems receiving flows greater than 5,000 gallons per day; community sewage systems as defined in Section 7-245, Connecticut General Statutes, which utilize land treatment and disposal, alternative on-site sewage treatment systems; and septage disposal systems which utilize land treatment and disposal.

### Sec. 19-13-B104b - Definitions

- (a) **Alternative on-site sewage treatment systems** means a system serving one or more buildings on one property which utilizes a method of treatment other than a subsurface sewage disposal system and which involves a discharge to the waters of the state.
- (b) **Domestic sewage** means sewage that consists of water and human excretions or other waterborne wastes incidental to the occupancy of the residential buildings or a nonresidential building but not including manufacturing process water, cooling water, wastewater from water softening equipment, commercial laundry wastewater, blowdown from heating or cooling equipment, water from cellars or floor drains or surface water from roofs, paved surfaces or yard drains.
- (c) **House sewer** means a tight sewer pipe extending from the building served by a subsurface sewage disposal system.
- (d) **Land treatment and disposal** means a system which utilizes soil materials for the treatment of domestic sewage and disposes of the treated effluent by percolation into underlying soil and mixing with the groundwater.
- (e) **Local Director of Health** means the local director of health or his authorized agent.
- (f) **Person** means any individual, partnership, association, firm, corporation or other entity, except a municipality, and includes the federal government, the state or any instrumentality of the state and any officer or governing or managing body of any partnership, association, firm or corporation.
- (g) **Septage** means any water of material withdrawn from a septic tank used to treat domestic sewage.
- (h) **Subsurface sewage disposal system** means a system consisting of a house or collection sewer, a septic tank followed by a leaching system, any necessary pumps or siphons, and any groundwater control system on which the operation of the leaching system is dependent.

### Sec. 19-13-B104c - General Provisions

- (a) All sewers, sewage disposal systems, toilets, or sewage plumbing systems shall be kept in a sanitary condition at all times and be so constructed and maintained as to prevent the escape of odors and to exclude animals and insects. All such systems shall adhere to the requirements set forth in Section 25-54i of the Connecticut General Statutes.
- (b) The contents of the septic tank, subsurface sewage disposal system or privy vault shall only be disposed of in the following manner.

- (1) If the contents are to be disposed of on the land of the owner, disposal shall be by burial or other method which does not present a health hazard or nuisance; or
- (2) If the contents are to be disposed of on land of other than the owner;
  - (A) The contents shall be transferred and removed by a cleaner licensed pursuant to Connecticut General Statutes Chapter 393a, and
  - (B) Only on the application for and an issuance of a written permit from the local director of health in accordance with the provisions of this section;
- (3) If the contents are to be disposed of on a public water supply watershed, only on the application and issuance of a written permit by the Commissioner of Public Health in accordance with the provisions of this section.

Each application for a permit under subdivisions (2) and (3) of subsection (b) shall be in writing and designate where and in what manner the material shall be disposed of.

- (c) All material removed from any septic tank, privy, sewer, subsurface sewage disposal system, sewage holding tank, toilet or sewage plumbing system shall be transported in watertight vehicles or containers in such a manner that no nuisance or public health hazard is presented. All vehicles used for transportation of such material shall bear the name of the company or licensee and shall be maintained and clean exterior conditions at all times. No defective or leaking equipment shall be used in cleaning operations. All vehicles or equipment shall be stored in a clean condition when not in use. Water used for rinsing such vehicles or equipment shall be considered sewage and shall be disposed of in a sanitary manner approved by the local director of health.
- (d) Septic tanks shall be cleaned by first lowering the liquid level sufficiently below the outlet to prevent sludge or scum from overflowing to the leaching system where it could cause clogging or otherwise damage the system. Substantially all of the sludge or scum accumulation shall be removed whenever possible, and the inlet and outlet baffles shall be inspected for damage or clogging. Cleaners shall use all reasonable precautions to prevent damaging the sewage disposal system with vehicles or equipment. Accidental spillage of sewage, sludge, or scum be promptly removed or otherwise abated so as to prevent a nuisance or public health hazard.
- (e) No sewage shall be allowed to discharge or flow into any storm drain, gutter, street, roadway or public place, nor shall such material discharge onto any private property so as to create a nuisance or condition detrimental to health. Whenever it is brought to the attention of the local director of health that such a condition exists on any property, he shall investigate and cause the abatement of this condition.
- (f) Persons who intend to conduct site investigations for the purpose of designing or constructing any septage or sewage disposal system within the scope of these regulations shall notify the local director of health of the time and place of such site investigations. Notice shall be provided to the local director of health in a timely manner to allow attendance at such site investigations by the director of health.
- (g) Persons who propose sewage or septage disposal systems within the scope of this regulation shall submit plans for such systems to the Commissioner of Public Health and the local director of health. Plans shall be submitted in a timely manner to allow review and comment on such plans to be directed to the Commissioner of Environmental Protection. Such plans shall be prepared by a professional engineer registered in the State of Connecticut and shall include a report of the findings of all site investigations, the basis of design, a preliminary or final design and other information necessary for the preservation and improvement of public health.
- (h) Persons who intend to construct sewage or septage disposal systems within the scope of these regulations shall file final construction plans with the local director of health at least two working days prior to the start of construction. All such systems shall be inspected during construction by the local director of health. Persons constructing such systems shall give prior notification to the local director of health of any changes which are proposed or required during construction. Persons constructing such systems shall provide the local director of health with a record drawing of the system, as-built, prior to utilizing the system.

**Sec. 19-13-B104d - Minimum Requirements**

- (a) All sewage or septage disposal systems under the scope of these regulations shall meet the following minimum requirements necessary for the preservation and improvement of public health, unless an exception is granted by the Commissioner of Public Health upon his determination that public health shall not be impaired by such exception.
- (b) All structures or facilities for the treatment or disposal of sewage or septage shall be located at least 50 feet from any open water source and 100 feet from any public supply reservoir, unless designed and constructed to prevent the leakage or overflow of raw or treated sewage to the ground or surface water.
- (c) All structures, facilities or locations containing sewage or septage which is exposed to the atmosphere shall be located at least 150 feet from any school, residential building or institution, and shall be fenced or otherwise made inaccessible to the public.
- (d) The following minimum separating distances shall be maintained between any discharge or overflow of raw or treated sewage or septage to the ground waters and any drinking water supply well or spring.

Required Withdrawal Rate	Minimum Separation Distance
Under 10 gallons per minute	75 feet
10 to 50 gallons per minute	150 feet
Over 50 gallons per minute	200 feet

- (e) The following minimum separating distances shall be maintained between any sewer, structure or facility for the conveyance or treatment of sewage or septage and any drinking water supply well or spring.

Required Withdrawal Rate	Minimum Separation Distance
Under 10 gallons per minute	25 feet
10 to 50 gallons per minute	75 feet
Over 50 gallons per minute	100 feet

**Statement of Purpose**

The regulations up date existing Public Health Code requirements for the design and installation of large subsurface sewage disposal systems, the design flow of which exceed 5,000 gallons per day. Sewage disposal systems conforming to this regulation and designed to include the latest state-of-the-art technology will provide for the preservation and improvement of public health.